



# Pre-Engineered ILP Automatic Suppression Unit

*Designed for use with:*  
**ABC Dry Chemical Powder**

## DESIGN, INSTALLATION, OPERATION, AND MAINTENANCE MANUAL

**Firetrace International**

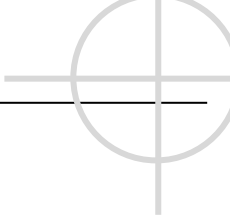
8435 N. 90<sup>th</sup> Street, Suite 2 • Scottsdale, AZ 85258 USA • +1-480-607-1218 • +1-480-315-1316 (Fax) • [www.firetrace.com](http://www.firetrace.com)

DIOM 800011-000

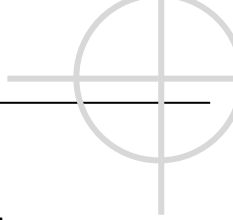


10/27/2017

FM Approvals File: 3053678

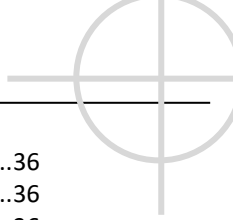


THIS PAGE INTENTIONALLY LEFT BLANK

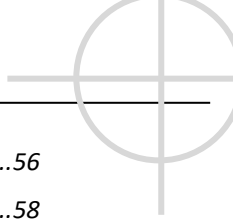


# Table of Contents

SECTION	Page Number
<b>FOREWARD</b> .....	<b>9</b>
<i>General</i> .....	9
<i>Safety Messages</i> .....	9
<i>Safety Precautions</i> .....	10
<b>Section 1: General Information</b> .....	<b>11</b>
1.1 <i>Introduction</i> .....	11
1.2 <i>ABC Dry Chemical Powder</i> .....	11
1.2.1 <i>Cleanliness</i> .....	11
1.2.2 <i>Agent Properties</i> .....	11
<b>Section 2: System Description</b> .....	<b>12</b>
2.1 <i>General Description</i> .....	12
2.2 <i>Cylinders</i> .....	13
2.3 <i>Cylinder Valves</i> .....	14
2.4 <i>Firetrace Detection Tubing</i> .....	15
2.5 <i>Manual Release</i> .....	16
2.6 <i>Cylinder Mounting Bracket</i> .....	17
2.7 <i>Heavy Duty Mounting Bracket</i> .....	18
2.8 <i>Discharge Network</i> .....	19
2.8.1 <i>Pipe, Fittings, and Pipe Supports</i> .....	19
2.8.1.1 <i>Pipe Requirements</i> .....	19
2.8.1.2 <i>Pipe Fittings and Pipe Joining</i> .....	19
2.8.1.3 <i>Pipe Supports</i> .....	19
2.8.2 <i>Flexible Hoses and Fittings</i> .....	20
2.8.2.1 <i>Flexible Hoses</i> .....	20
2.8.2.2 <i>Flexible Hose Fittings</i> .....	21
2.8.3 <i>Nozzles</i> .....	23
2.9 <i>Pressure Switches</i> .....	24
2.9.1 <i>Valve Mounted Pressure Switch</i> .....	24
2.9.2 <i>End of Line Pressure Switch</i> .....	26
2.9.3 <i>Pressure Switch Assembly</i> .....	28
2.10 <i>Electric Solenoid Assembly</i> .....	30
2.11 <i>Indication and Activation Kit</i> .....	32
<b>Section 3: Design</b> .....	<b>34</b>
3.1 <i>Introduction</i> .....	34
3.2 <i>Operating Specifications</i> .....	34
3.2.1 <i>Temperature Range</i> .....	34
3.2.2 <i>Operating Pressure</i> .....	34
3.3 <i>Design Procedure</i> .....	35
3.4 <i>Protected Enclosure</i> .....	36

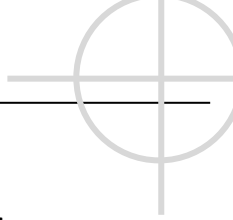


3.4.1	Enclosure Size .....	36
3.4.2	Ventilation and Unclosable Openings.....	36
3.4.3	Unclosable Opening Percentage.....	36
3.5	<i>Discharge Network</i> .....	37
3.5.1	Discharge Piping and Pipe Fitting Specifications .....	37
3.5.2	Discharge Piping and Pipe Fitting Limitations.....	37
3.5.3	Discharge Pipe Bends.....	39
3.5.4	Nozzle Area Coverage .....	39
3.6	<i>Firetrace Detection Tubing</i> .....	42
<b>Section 4:</b>	<b>Installation</b> .....	<b>44</b>
4.1	<i>Introduction</i> .....	44
4.2	<i>Firetrace ABC Powder ILP Unit</i> .....	44
4.3	<i>Discharge Network</i> .....	45
4.4	<i>Detection Network</i> .....	45
4.4.1	Firetrace Detection Tubing .....	45
4.4.2	Tube Fittings .....	45
4.4.3	End of Line Accessories.....	45
4.4.3.1	Pressure Gauge .....	45
4.4.3.2	Pressure Switch.....	46
4.4.3.3	Plug .....	46
<b>Section 5:</b>	<b>Operation</b> .....	<b>47</b>
5.1	<i>System Activation</i> .....	47
<b>Section 6:</b>	<b>Maintenance</b> .....	<b>48</b>
6.1	<i>General</i> .....	48
6.2	<i>Maintenance Schedule</i> .....	48
6.2.1	Monthly .....	48
6.2.2	Semi-Annual.....	49
6.2.3	Five-Year .....	50
6.3	<i>Firetrace Detection Tubing Maintenance</i> .....	50
6.4	<i>ABC Powder Maintenance</i> .....	51
6.5	<i>Cylinder Maintenance</i> .....	52
<b>Section 7:</b>	<b>Recharge</b> .....	<b>53</b>
7.1	<i>General</i> .....	53
7.2	<i>Recharge</i> .....	53
<b>Section 8:</b>	<b>Post Discharge</b> .....	<b>54</b>
8.1	<i>Ventilation</i> .....	54
8.2	<i>Remove from Service</i> .....	54
8.3	<i>Recharge</i> .....	54
8.4	<i>Return to Service</i> .....	54
<b>Appendix A – Parts List</b> .....		<b>55</b>
	<i>Firetrace ABC Powder ILP Automatic Suppression Unit Assemblies</i> .....	55
	<i>Heavy Duty Brackets</i> .....	55



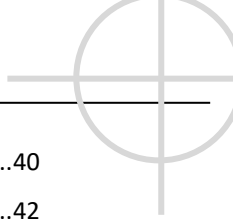
---

<i>Discharge Network</i> .....	56
<i>Detection Network</i> .....	58
<i>Miscellaneous</i> .....	59
<b>Appendix B – System Commissioning Form</b> .....	<b>60</b>
<b>Appendix C – SDS</b> .....	<b>61</b>



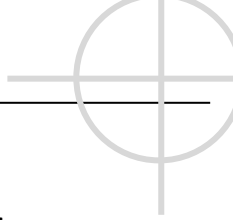
# List of Tables

<b>Table</b>	<b>Page Number</b>
Table 1 – Cylinder Specifications .....	13
Table 2 – Unit Assembly Dimensions.....	13
Table 3 – Firetrace Detection Tubing Properties.....	15
Table 4 – Firetrace Detection Tube Part Numbers .....	15
Table 5 – Manual Release Part Numbers.....	16
Table 6 – 940202 Cylinder Mounting Bracket Dimensions.....	17
Table 7 – 940502 Cylinder Mounting Bracket Dimensions.....	17
Table 8 – 941002 Cylinder Mounting Bracket Dimensions.....	17
Table 9 – 942002 Cylinder Mounting Bracket Dimensions.....	17
Table 10 – Heavy Duty Mounting Bracket Dimensions .....	18
Table 11 – Copper Fitting Part Numbers for 940202 Unit Assembly.....	19
Table 12 – Copper Fitting Part Numbers for 940502/941002/942002 Unit Assembly.....	19
Table 13 – Flexible Hose Part Numbers for 940202 Unit Assembly .....	20
Table 14 – Flexible Hose Part Numbers for 940502/941002/942002 Unit Assembly .....	21
Table 15 – Flexible Hose Fitting Part Numbers for 940202 Unit Assembly .....	22
Table 16 – Flexible Hose Fitting Part Numbers for 940502/941002/942002 Unit Assembly .....	22
Table 17 – Nozzle Part Numbers .....	23
Table 18 – Valve Mounted Pressure Switch Part Number.....	25
Table 19 – Pressure Switch Properties .....	25
Table 20 – End of Line Pressure Switch Part Number .....	27
Table 21 – End of Line Pressure Switch Properties.....	27
Table 22 –Pressure Switch Assembly Part Number .....	28
Table 23 – Pressure Switch Assembly Properties .....	29
Table 24 – Electric Solenoid Assembly Part Number.....	31
Table 25 – Electric Solenoid Assembly Properties .....	31
Table 26 – Indication and Activation Kit Part Number .....	33
Table 27 – Pressure-Temperature Relationship .....	35
Table 28 – Enclosure Size Limitations for Firetrace ABC Powder ILP Units .....	36
Table 29 – Discharge Piping Specifications.....	37
Table 30 – Discharge Pipe Fitting Specifications.....	37
Table 31 – Discharge Piping Limitations .....	37
Table 32 – Pipe Fitting Limitations.....	38
Table 33 –Pipe Bend Radius and Equivalent Length .....	39



---

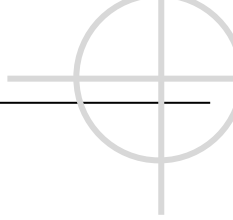
Table 34 – Nozzle Area Coverage Limitations.....	40
Table 35 – Firetrace Detection Tubing Limitations.....	42
Table 36 – Cylinder Maintenance .....	52
Table 37 – Firetrace ABC Powder ILP Units .....	55
Table 38 – Heavy Duty Bracket Assembly.....	55
Table 39 – Small ILP Discharge Network Copper Fittings .....	56
Table 40 – Medium/Large ILP Discharge Network Copper Fittings .....	56
Table 41 – Small ILP Discharge Network Flexible Hoses.....	56
Table 42 – Medium/Large ILP Discharge Network Flexible Hoses.....	56
Table 43 – Small ILP Discharge Network Flexible Hose Fittings.....	57
Table 44 – Medium/Large ILP Discharge Network Flexible Hose Fittings .....	57
Table 45 – Nozzles .....	57
Table 46 – Firetrace Detection Tubing.....	58
Table 47 – Tube Fittings.....	58
Table 48 – End of Line Accessories .....	58
Table 49 – Installation Accessories .....	59
Table 50 – Auxiliary Accessories .....	59
Table 51 – Indication and Activation Kits .....	59



# List of Figures

<b>Figure</b>	<b>Page Number</b>
Figure 1 – Unit Assembly .....	13
Figure 2 – Cylinder Valves.....	14
Figure 3 – Manual Releases .....	16
Figure 4 – Cylinder Mounting Bracket Bolt Pattern.....	17
Figure 5 – Heavy Duty Mounting Bracket Bolt Pattern.....	18
Figure 6 – Flexible Hoses .....	20
Figure 7 – Flexible Hose Fittings .....	21
Figure 8 – Nozzles .....	23
Figure 9 – Valve Mounted Pressure Switch .....	24
Figure 10 – Valve Mounted Pressure Switch Wiring Schematic .....	25
Figure 11 – End of Line Pressure Switch .....	26
Figure 12 – End of Line Pressure Switch Wiring Schematic .....	27
Figure 13 – Pressure Switch Assembly .....	28
Figure 14 – Pressure Switch Assembly Wiring Schematic .....	29
Figure 15 – Electric Solenoid Assembly .....	30
Figure 16 – Electric Solenoid Assembly Wiring Schematic .....	31
Figure 17 – Indication and Activation Kit.....	32
Figure 18 – Typical Tee Fitting Configuration Guideline.....	38
Figure 19 – Typical Nozzle Configuration Guideline .....	41
Figure 20 – Tubing Configuration Guideline .....	43





---

# FOREWARD

## General

This manual is written for the fire protection professional that designs, installs, and maintains Firetrace Pre-Engineered ILP Automatic Suppression Units with Dry Chemical Powder. It is intended to communicate details and procedures required for proper design, installation, operation, and maintenance.

Firetrace assumes no responsibility for the design or function of any systems other than those addressed in this manual. The technical data contained herein is limited strictly for informational purposes only.

Pre-Engineered ILP Automatic Suppression Units with Dry Chemical Powder are to be designed, installed, inspected, tested, maintained, and recharged by qualified trained personnel in accordance with the following:

- All instructions, limitations, etc. contained in this manual, DIOM 800011
- All information contained on the agent cylinder nameplate(s)
- NFPA 17: Standard for Dry Chemical Extinguishing Systems
- FM Approvals Listing
- Local authority having jurisdiction

## Safety Messages

The following notations are used throughout this manual. Always read and obey all safety messages. They are essential to the safe use of the equipment described in this manual.

### **DANGER**

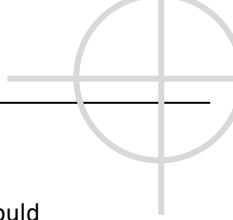
Identifies immediate hazards and provides specific instructions or procedures, which if not correctly followed **COULD** result in severe personal injury or death.

### **WARNING**

Identifies specific instructions or procedures, which if not correctly followed, **COULD** result in severe personal injury or death.

### **CAUTION**

Identifies specific instructions or procedures, which if not correctly followed, **COULD** result in minor personal injury or equipment or property damage.



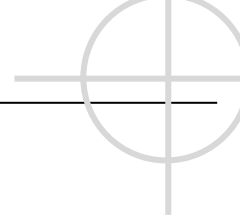
## Safety Precautions

Safety precautions are essential when any electrical or mechanical equipment is involved. These precautions should be followed when handling, servicing, and recharging Firetrace Pre-Engineered ILP Automatic Suppression Units and equipment. The following safety precautions should always be followed:

- Read and understand this entire manual and any other documents referenced herein.
- Secure the manual near the Firetrace fire suppression unit after installation.
- Periodic checks by trained personnel are required to ensure safe operation.
- All Firetrace Pre-Engineered ILP Automatic Suppression Units are factory equipped with discharge port plugs. The discharge port plugs are only to be removed when the Firetrace ILP Unit is connected into the discharge piping or when performing charging, testing, or salvaging operations in accordance with the procedures contained in this manual.
- Ensure the lever on the Firetrace ILP Unit ball valve is in the “OFF” position when not connected into the discharge piping or when performing charging, testing, or salvaging operations in accordance with the procedures contained in this manual.
- Never assume that a cylinder is empty. Treat all cylinders as if they are fully charged.
- Wear safety glasses when working with pressurized cylinders and charging equipment.
- Follow all safety procedures included on the cylinder nameplate and in this manual.

Questions regarding the information contained in this manual can be addressed to:

Firetrace International  
8435 N. 90th Street, Suite 2  
Scottsdale, AZ 85258 USA  
Phone: +1.480.607.1218  
Fax: +1.480.315.1316  
Web: [www.firetrace.com](http://www.firetrace.com)



## Section 1: General Information

### 1.1 Introduction

The Firetrace Pre-Engineered ILP Automatic Suppression Units with ABC Dry Chemical Powder are approved by FM Approvals. These units are designed for total flooding applications using ABC Dry Chemical Powder in accordance with NFPA 17: Standard for Dry Chemical Extinguishing Systems.

The Firetrace Pre-Engineered ILP Automatic Suppression Units with ABC Dry Chemical Powder have been tested to limits established by FM Approvals in compliance with the requirements specified in FM 5320 Approval Standard for Dry Chemical Extinguishing Systems and as detailed in this manual.

The pre-engineered concept of automatic fire suppression systems minimizes the amount of engineering involved in system design. When the discharge piping and nozzles are installed within the limitations stated in this manual, no hydraulic calculations are required to determine pressure drop, agent flow, or discharge time.

The hazard being protected by a Firetrace Pre-Engineered ILP Automatic Suppression Unit can be any size, shape, or volume; provided that the protected enclosure is within the limitations described in this manual. Once fully installed, the Firetrace Pre-Engineered ILP Automatic Suppression Unit becomes a self-contained unit, meaning that it is equipped with all the components necessary to detect and suppress Class B fires.

Since the units are listed as automatic units (e.g. no manual or electric means is necessary for activation), only one extinguisher unit can be used to protect one enclosure. The listed automatic units are not designed to provide simultaneous actuation of two or more units, therefore listed extinguisher units **cannot** be combined to protect a larger enclosure.

Local authorities having jurisdiction should be consulted as to the acceptability for particular hazards and requirements covering installation.

### 1.2 ABC Dry Chemical Powder

Firetrace Pre-Engineered ILP Automatic Suppression Units utilize mono ammonium phosphate, more commonly known as ABC Dry Chemical Powder or ABC Powder.

ABC Powder is depicted by the chemical formula  $\text{NH}_4\text{H}_2\text{PO}_4$ . ABC Powder is a finely divided powder that has been treated to be a water repellent. Under the influence of an expellant gas, ABC Powder is capable of being fluidized and free flowing in order to be discharged through a discharge piping network.

ABC Powder is included in NFPA 17. It has been evaluated and approved for use in occupied areas provided the proper safety precautions have been taken.

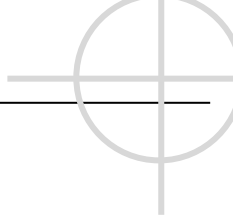
#### 1.2.1 Cleanliness

ABC Powder can be cleaned up by one of the following methods; wiping, vacuuming, or washing the exposed areas. In some cases, the powder must be scraped off a surface if that surface was hot at the time of discharge.

In the presence of moisture, ABC Powder can stain or corrode some types of metal surface. To minimize possible staining or corrosion, the exposed areas should be cleaned immediately.

#### 1.2.2 Agent Properties

For hazard information, decomposition information, and physical properties of ABC Powder, please refer to the Safety Data Sheet located in Appendix C.



## Section 2: System Description

### 2.1 General Description

Firetrace Pre-Engineered ILP Automatic Suppression Units are intended to be designed and installed to protect hazards within the limitations as stated in this manual ONLY. The equipment described in this manual is approved by FM Approvals, in accordance with FM 5320 Approval Standard for Dry Chemical Extinguishing Systems. The authority having jurisdiction should follow the information specified by this manual, NFPA 17: Standard for Dry Chemical Fire Extinguishing Systems, and any other applicable standards.

Firetrace Pre-Engineered ILP Automatic Suppression Units consists of the following major components:

- Cylinder/Valve Assembly
- Cylinder Mounting Bracket
- Firetrace Detection Tubing (FDT) and fittings (no substitute)
- Pressure Switch
- Discharge Piping and Fittings (furnished by others)

Once installed, the Pre-Engineered ILP Automatic Suppression Unit becomes a self-contained, self-actuating unit that does not require an external source of power.

The unit utilizes a UL recognized component (per UL standard 521) Linear Heat Detector (See Certificate of Compliance 20140705-S35465) known as Firetrace Automatic Fire Detection Tubing. When pressurized with dry nitrogen, it will allow the fire suppression valve to remain in the closed position. The tubing acts as a continuous linear thermal detector that ruptures upon direct flame impingement or at temperatures above 383 °F (195 °C). Once the detection tubing is ruptured, the valve automatically opens, allowing the ABC Powder to flow through the discharge piping, distributing the extinguishing agent through the nozzle(s) into the protected enclosure.

Firetrace Pre-Engineered ILP Automatic Suppression Units are designed for use in total flooding applications only, where the hazard is normally unoccupied. Firetrace Pre-Engineered ILP Automatic Suppression Units can be used, but are not limited, to protect the following:

- Laboratory fume hoods
- Flammable chemicals storage cabinets
- CNC & VMC machining centers
- Pump enclosures
- Generator enclosures
- Many other applications

ABC Powder should not be used where the following materials may be present:

- Pyrotechnic chemicals containing their own oxygen supply
- Reactive metals
- Metal hydrides
- Chemicals capable of undergoing autothermal decompositions
- Deep seated or burrowing fires in ordinary combustibles where point of combustion cannot be reached

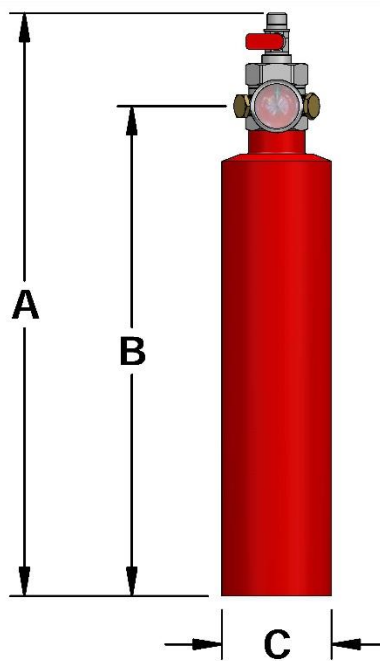
For hazards beyond the scope described above, it is recommended that the designer consult with Firetrace, NFPA 17, and the local authority having jurisdiction as to the suitability on the use of ABC Powder for a particular hazard, for personnel exposure effects, and for installation requirements.

## 2.2 Cylinders

ABC Powder is stored in the pre-engineered unit cylinders. The steel cylinders are available in the following nominal capacities: 2.5 lb, 5 lb, 10 lb and 20 lb. Additionally, an enhanced durability coating is available for the exterior of the unit cylinders. Refer to Table 1 – Cylinder Specifications, Figure 1 – Unit Assembly and Table 2 – Unit Assembly Dimensions for additional details.

**Table 1 – Cylinder Specifications**

Nominal Capacity	Volume		Cylinder Specification	Cylinder Service Pressure		Cylinder Test Pressure	
	in <sup>3</sup>	cm <sup>3</sup>		psig	bar	psig	bar
2.5 lb	75	1229	DOT 4B240	240	16.5	480	33.1
5 lb	145	2376	DOT 4B240	240	16.5	480	33.1
10 lb	300	4916	DOT 4B360	360	24.8	720	49.6
20 lb	676	11077	UL 299	195	13.4	585	40.3



**Figure 1 – Unit Assembly**

**Table 2 – Unit Assembly Dimensions**

Unit Assembly Part Number	Agent		Dimension "A"		Dimension "B"		Dimension "C"	
	lb	kg	in	cm	in	cm	in	cm
940202	2.5	1.13	15.6	39.6	13.1	33.3	2.9	7.4
940502	5	2.27	16.6	42.2	13.5	34.3	4.3	10.9
941002	10	4.54	16.7	42.4	13.7	34.8	6.3	16.0
942002	20	9.07	24.1	61.2	21.0	53.3	7.1	18.0

## 2.3 Cylinder Valves

Each cylinder is equipped with a nickel plated brass valve. The cylinder valves are backpressure type valves. A piston in the valve bore is equipped with a rubber seal that keeps the ABC Powder under pressure within the cylinder. A small hole in the piston allows cylinder pressure to equalize on both sides of the piston. Since the surface area above the piston is greater than the surface area below the piston, the net force seals the piston against the primary valve seal. When the pressure above the piston is relieved by any means, there is only cylinder pressure acting against the piston seal and the piston slides to its fully open position, allowing for agent discharge.

The valve is equipped with a pressure gauge to monitor cylinder pressure and a quarter turn ball valve that interfaces with the Firetrace Detection Tubing. The ball valve must be kept closed at all times when the cylinder is not in service.

The 940202 unit assembly is equipped with a small ILP valve containing two 1/4 in NPT discharge ports. The 940502, 941002, and 942002 unit assemblies are equipped with a medium ILP valve containing two 1/2 in NPT discharge ports. Refer to Figure 2 – Cylinder Valves for additional valve information.

**NOTE: All Firetrace ABC Powder ILP Units utilize a straight siphon tube. All Firetrace ABC Powder ILP Units are to be installed only in a vertical (valve on top) position.**

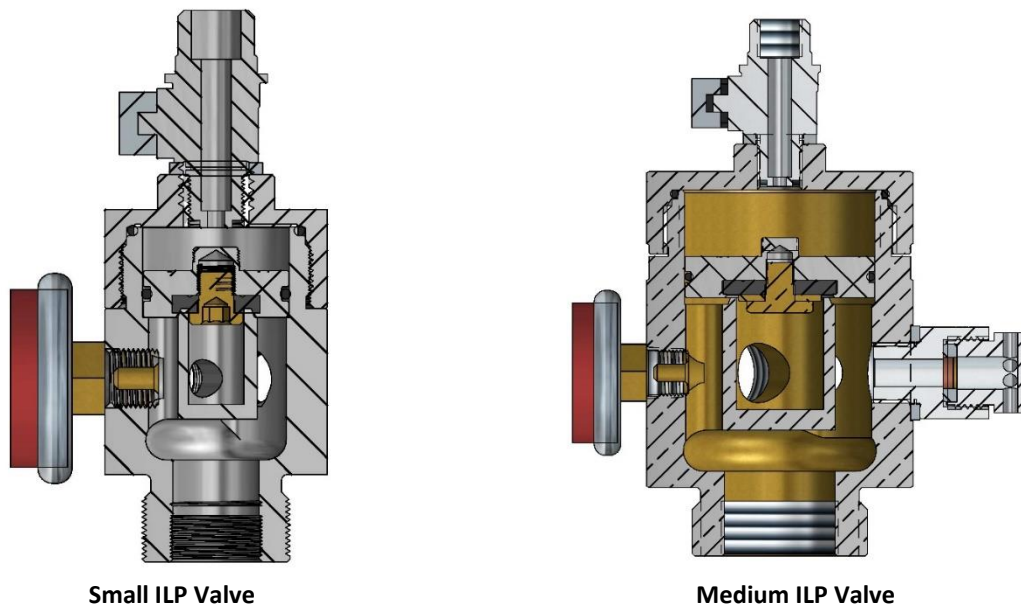
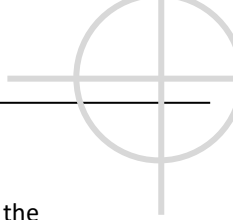


Figure 2 – Cylinder Valves

### **CAUTION**

All cylinder valves are factory equipped with discharge port plugs. The discharge port plugs **SHALL** be installed in the valve discharge ports at all times, unless the discharge ports are connected to the discharge piping.



## 2.4 Firetrace Detection Tubing

The Firetrace Detection Tubing is a linear, pneumatic, fire detection device that responds to a combination of the heat and radiant energy from a fire. The tubing is a UL recognized component per UL Standard 521 (see Certificate of Compliance 20140705-S35465). The Firetrace detection tubing performs two functions: heat detection and system activation. One end of the tubing is installed to the top of the cylinder valve. The tubing is then installed throughout the enclosure and finally pressurized with nitrogen.

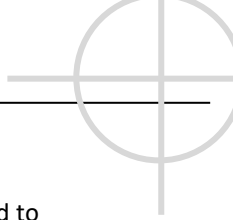
The Firetrace detection tubing is heat sensitive and in a fire situation, is designed to rupture at any point along its length upon direct flame impingement or when the temperature reaches above 383 °F [195 °C]. The rupture of the tubing releases the nitrogen pressure causing the unit to actuate. The actuation results in a complete discharge of the ABC Powder through the discharge piping and is distributed by the nozzle(s) throughout the protected enclosure. Refer to Table 3 - Firetrace Detection Tubing Properties and Table 4 – Firetrace Detection Tube Part Numbers for additional information.

**Table 3 - Firetrace Detection Tubing Properties**

Hydrostatic Burst Pressure	Minimum Burst Pressure	1100 psig [75 bar]
	Typical Burst Pressure	1300 psig [88 bar]
Electrical Properties	Volume Resistivity	1014 (per DIN 53481)
	Dielectric Strength	40k V/mm (per DIN 53481)

**Table 4 – Firetrace Detection Tube Part Numbers**

Firetrace Detection Tubing Part Number	Description
200005	Firetrace Detection Tubing, 4/6 mm, 1 ft
204025	Firetrace Detection Tubing, 4/6 mm, 25 ft
204050	Firetrace Detection Tubing, 4/6 mm, 50 ft
204100	Firetrace Detection Tubing, 4/6 mm, 100 ft
204328	Firetrace Detection Tubing, 4/6 mm, 328 ft



## 2.5 Manual Release

The manual release is used as an optional part of the system detection line network. The manual release is used to manually release the nitrogen pressure in the tubing, causing the system to actuate. The actuation results in a complete discharge of the unit assembly.

The tube fitting on the body of the manual release allows for easy installation onto the system detection line network. The pull tab on the plunger prevents accidental activation of the manual release. The port on the body of the manual release is used to pressurize the tubing and allows for installation of a pressure gauge to monitor system pressure, refer to Figure 3 – Manual Releases and Table 5 – Manual Release Part Numbers for additional information.

### **CAUTION**

**Do not remove the pull tab until ready to actuate system discharge.**

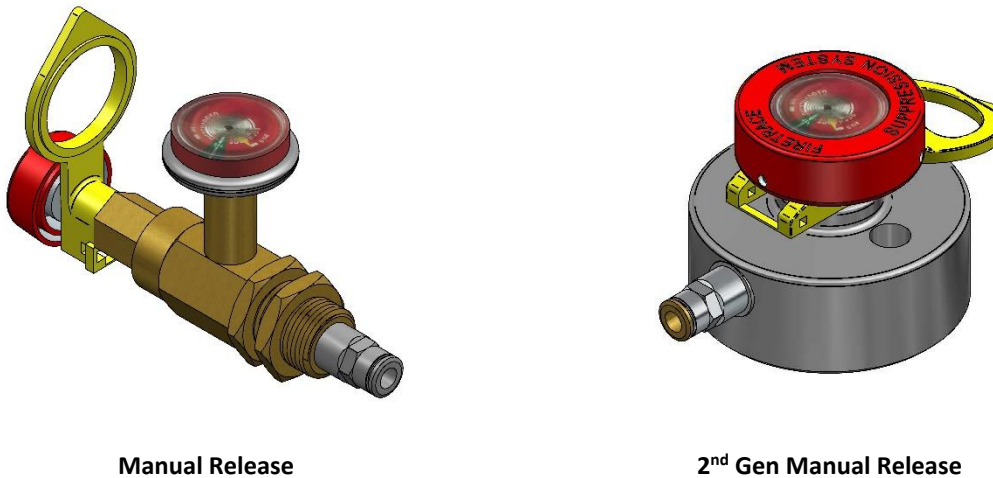


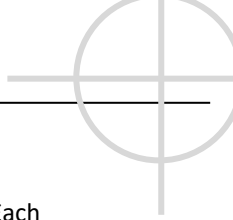
Figure 3 – Manual Releases

Table 5 – Manual Release Part Numbers

Manual Release Part Numbers	Description
600063*	Manual Release, ABC Powder
601012	2 <sup>nd</sup> Gen Manual Release, ABC Powder

\* This is an optional component and is not part of an FM Approved System.





## 2.6 Cylinder Mounting Bracket

The cylinder mounting brackets are manufactured from steel with a primed and powder coated paint finish. Each cylinder mounting bracket is designed to fit properly around the cylinder. The cylinder mounting bracket is equipped with finger tabs which allow easy access. The cylinder mounting bracket must be secured to a surface appropriate for retaining the weight of the cylinder in the event of a discharge. This precaution is intended to safely support the weight of the cylinder and the reaction force of the ABC Powder discharge.

All cylinders must be mounted vertically only, with the valve on top. Please refer to Figure 4 – Cylinder Mounting Bracket Bolt Pattern, Table 6 – 940202 Cylinder Mounting Bracket Dimensions, Table 7 – 940502 Cylinder Mounting Bracket Dimensions, Table 8 – 941002 Cylinder Mounting Bracket Dimensions, and Table 9 – 942002 Cylinder Mounting Bracket Dimensions for cylinder mounting bracket dimensions.

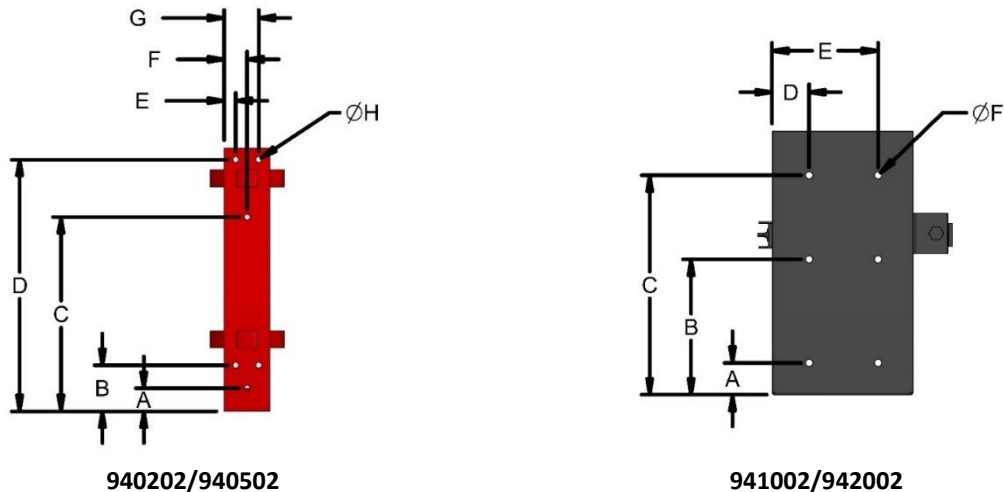


Figure 4 – Cylinder Mounting Bracket Bolt Pattern

Table 6 – 940202 Cylinder Mounting Bracket Dimensions

"A"		"B"		"C"		"D"		"E"		"F"		"G"		"H"	
in	cm	in	cm	in	cm	in	cm	in	cm	in	cm	in	cm	in	cm
1.0	2.7	2.0	5.2	8.4	23.0	10.9	28.0	.5	1.3	1.0	2.7	1.5	3.8	1/4	0.6

Table 7 – 940502 Cylinder Mounting Bracket Dimensions

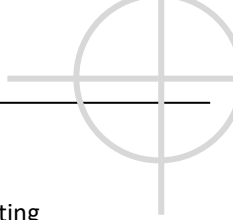
"A"		"B"		"C"		"D"		"E"		"F"		"G"		"H"	
in	cm	in	cm	in	cm	in	cm	in	cm	in	cm	in	cm	in	cm
1.0	2.7	2.0	5.2	8.4	23.0	10.9	28.0	.5	1.3	1.0	2.7	1.5	3.8	1/4	0.6

Table 8 – 941002 Cylinder Mounting Bracket Dimensions

"A"		"B"		"C"		"D"		"E"		"F"	
in	cm	in	cm	in	cm	in	cm	in	cm	in	cm
1.4	3.6	5.9	15.0	9.4	23.9	1.6	4.1	4.6	11.7	7/16	0.8

Table 9 – 942002 Cylinder Mounting Bracket Dimensions

"A"		"B"		"C"		"D"		"E"		"F"	
in	cm	in	cm	in	cm	in	cm	in	cm	in	cm
2.3	5.8	7.4	18.8	12	30.5	1.5	3.8	5.1	13.0	7/16	0.8



## 2.7 Heavy Duty Mounting Bracket

Additionally, the cylinder mounting brackets are available in a heavy duty configuration. The heavy duty mounting brackets are manufactured of higher strength steel with a primed and powder coated paint finish. The heavy duty mounting brackets provide greater stability against vibration.

The heavy duty mounting brackets are equipped with band clamps designed to fit properly around the cylinder. The heavy duty mounting bracket must be secured to a surface appropriate for retaining the weight of the cylinder in the event of a discharge. This precaution is intended to safely support the weight of the cylinder and the reaction force of the ABC Powder discharge.

All cylinders must be mounted vertically only, with the valve up. Please refer to Figure 5 – Heavy Duty Mounting Bracket Bolt Pattern and Table 10 – Heavy Duty Mounting Bracket Dimensions for cylinder mounting bracket dimensions.

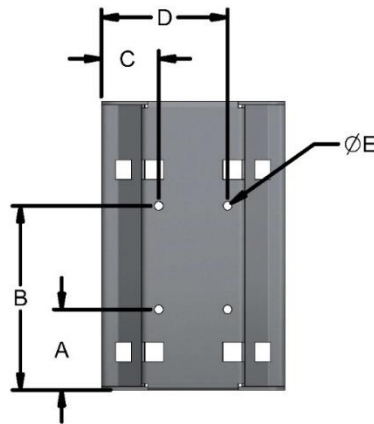


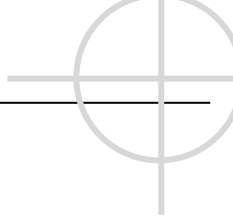
Figure 5 – Heavy Duty Mounting Bracket Bolt Pattern

Table 10 – Heavy Duty Mounting Bracket Dimensions

Assembly Part Number	Dimension "A"		Dimension "B"		Dimension "C"		Dimension "D"		Dimension "E"	
	in	cm	in	cm	in	cm	in	cm	in	cm
111404	4.1	10.4	8.1	20.6	1.9	4.8	2.6	6.6	.3	0.8
111403	4.1	10.4	8.1	20.6	2.1	5.3	3.8	9.7	.4	1.0
111402	3.5	8.9	8.0	20.3	2.5	6.4	5.5	14.0	.4	1.0
111400	3.0	7.6	10.0	25.4	2.5	6.4	5.5	14.0	.4	1.0

NOTE: All systems come equipped with a standard bracket. The Heavy Duty Mounting Brackets are available as an optional accessory for all systems.

NOTE: The heavy duty mounting bracket assembly includes the clamps necessary for strapping the unit into the bracket.



## 2.8 Discharge Network

### 2.8.1 Pipe, Fittings, and Pipe Supports

All piping must be installed in accordance with good commercial practices and applicable national standards.

#### 2.8.1.1 Pipe Requirements

Piping used for Firetrace ILP Units must be copper. Piping shall be in accordance with the requirements of NFPA 17 or the local authority having jurisdiction.

**NOTE: All piping must be thoroughly cleaned to remove burrs and swabbed with a degreasing solvent to remove all traces of cutting oils and chips.**

#### 2.8.1.2 Pipe Fittings and Pipe Joining

Piping, fittings, and pipe supports shall be in accordance with the latest edition of NFPA 17 available from National Fire Protection Association. Temperature and pressure ratings of the fittings must not be exceeded. The method of joining all pipe must be in accordance with the latest requirements listed in NFPA 17. Refer to Table 11 – Copper Fitting Part Numbers for 940202 Unit Assembly and Table 12 – Copper Fitting Part Numbers for 940502/941002/942002 Unit Assembly for acceptable fittings.

**Table 11 – Copper Fitting Part Numbers for 940202 Unit Assembly**

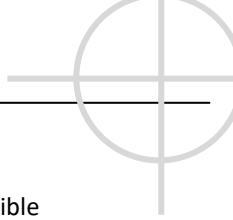
Copper Fitting Part Number	Description
200143	Copper Compression Fitting, Valve/Nozzle to 5/16 in Pipe
200101	Copper Compression Fitting, 5/16 in Pipe Bulkhead
200111	Copper Compression Fitting, 5/16 in Pipe Elbow
200121	Copper Compression Fitting, 5/16 in Pipe in Tee

**Table 12 – Copper Fitting Part Numbers for 940502/941002/942002 Unit Assembly**

Copper Fitting Part Number	Description
200144	Copper Compression Fitting, Valve/Nozzle to 1/2 in Pipe
200145	Copper Compression Fitting, 1/2 in Pipe Bulkhead
200112	Copper Compression Fitting, 1/2 in Pipe Elbow
200122	Copper Compression Fitting, 1/2 in Pipe in Tee

#### 2.8.1.3 Pipe Supports

Piping shall be securely supported by listed and/or approved hangers. Pipe supports must be installed with allowance for expansion and contraction and must be rated to support the dead weight of the piping and the thrust forces of the ABC Powder discharge.



## 2.8.2 Flexible Hoses and Fittings

Flexible hoses and flexible hose fittings are available as an optional part for the system discharge network. Flexible hoses and flexible hose fittings shall be in accordance with the latest edition of NFPA 17 or the local authority having jurisdiction. Temperature and pressure rating of the flexible hoses and flexible hose fittings shall not be exceeded.

### 2.8.2.1 Flexible Hoses

The flexible hoses are constructed with synthetic, high tensile textile cord reinforcement. Both ends are fitted with swivel adapters for easy installation. The flexible hoses have a maximum operating pressure of 300 psig [20.7 bar] and a minimum bend radius of 4 in [10.2 cm]. The 940202 unit assembly uses 3/8 in flexible hoses. The 940502, 941002 and 942002 unit assemblies use 1/2 in flexible hoses. Refer to Figure 6 – Flexible Hoses, Table 13 – Flexible Hose Part Numbers for 940202 Unit Assembly, and Table 14 – Flexible Hose Part Numbers for 940502/941002/942002 Unit Assembly for additional information.

**NOTE:** This is an optional component and is not part of an FM Approved System.

**NOTE:** When using flexible hoses for the discharge network, the total length of piping shall not exceed the maximum length found in Section 3.6.

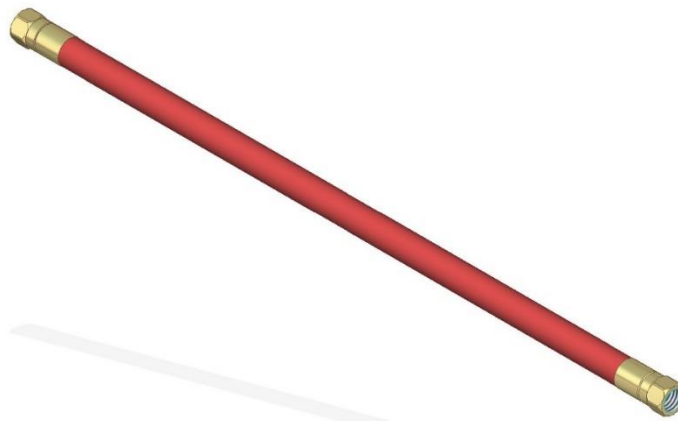
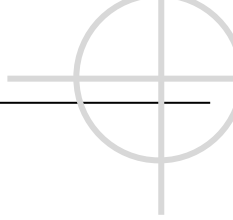


Figure 6 – Flexible Hoses

Table 13 – Flexible Hose Part Numbers for 940202 Unit Assembly

Flexible Hose Part Number	Description
202816 <sup>†</sup>	3/8 in Flexible Hose, 1 ft
201816 <sup>†</sup>	3/8 in Flexible Hose, 2 ft
201817 <sup>†</sup>	3/8 in Flexible Hose, 3 ft
201818 <sup>†</sup>	3/8 in Flexible Hose, 4 ft
201819 <sup>†</sup>	3/8 in Flexible Hose, 7 ft

<sup>†</sup> This is an optional component and is not part of an FM Approved System.



**Table 14 – Flexible Hose Part Numbers for 940502/941002/942002 Unit Assembly**

Flexible Hose Part Number	Description
202820 <sup>‡</sup>	1/2 in Flexible Hose, 1 ft
201820 <sup>‡</sup>	1/2 in Flexible Hose, 2 ft
201821 <sup>‡</sup>	1/2 in Flexible Hose, 4 ft
201822 <sup>‡</sup>	1/2 in Flexible Hose, 6 ft
201823 <sup>‡</sup>	1/2 in Flexible Hose, 8 ft
201824 <sup>‡</sup>	1/2 in Flexible Hose, 10 ft

### 2.8.2.2 Flexible Hose Fittings

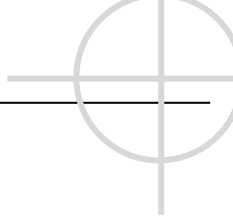
The flexible hose fittings are constructed of zinc plated steel. The flexible hose fittings allow for easy installation between the Firetrace ABC Powder ILP Units, the flexible hoses, and the system nozzles. The flexible hose fittings have a minimum burst rating of 3000 psig [206.8 bar]. Refer to Table 15 – Flexible Hose Fitting Part Numbers for 940202 Unit Assembly and Table 16 – Flexible Hose Fitting Part Numbers for 940502/941002/942002 Unit Assembly for additional information.

**NOTE: This is an optional component and is not part of an FM Approved System.**



**Figure 7 – Flexible Hose Fittings**

<sup>‡</sup> This part is an optional component and is not part of an FM Approved System.



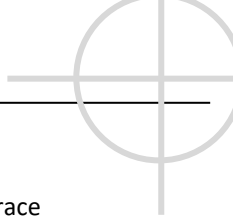
**Table 15 – Flexible Hose Fitting Part Numbers for 940202 Unit Assembly**

<b>Flexible Hose Fitting Part Number</b>	<b>Description</b>
850016 <sup>§</sup>	Fitting, 3/8 in Hose to Valve Union
850017 <sup>§</sup>	Fitting, 3/8 in Hose Union
850018 <sup>§</sup>	Fitting, 3/8 in Hose Elbow
850019 <sup>§</sup>	Fitting, 3/8 in Hose Tee
850020 <sup>§</sup>	Fitting, 3/8 in Hose to Nozzle Union Bulkhead
850021 <sup>§</sup>	Fitting, 3/8 in Hose to Nozzle Elbow Bulkhead

**Table 16 – Flexible Hose Fitting Part Numbers for 940502/941002/942002 Unit Assembly**

<b>Flexible Hose Fitting Part Number</b>	<b>Description</b>
850022 <sup>§</sup>	Fitting, 1/2 in Hose to Valve Union
850023 <sup>§</sup>	Fitting, 1/2 in Hose Union
850024 <sup>§</sup>	Fitting, 1/2 in Hose Elbow
850025 <sup>§</sup>	Fitting, 1/2 in Hose Tee
850026 <sup>§</sup>	Fitting, 1/2 in Hose to Nozzle Union Bulkhead
850027 <sup>§</sup>	Fitting, 1/2 in Hose to Nozzle Elbow Bulkhead

<sup>§</sup> This is an optional component and is not part of an FM Approved System.



### 2.8.3 Nozzles

Discharge nozzles are made of brass with female pipe threads. Nozzles are available in two sizes for use with Firetrace ILP ABC Powder Units. The small nozzles contain a ¼ in NPT thread. The medium nozzles contain a ½ in NPT thread. The 940202 unit assembly uses the small nozzle, see Figure 8 – Nozzles. The 940202 unit assembly can be designed using 1, 2, or 4 small nozzles. The 940502, 941002, and 942002 unit assemblies use the medium nozzles, Figure 8 – Nozzles. The 940502, 941002, and 942002 unit assemblies can be designed using 2 or 4 medium nozzles. The coverage for each nozzle must not exceed its maximum length and area of coverage. Refer to Section 3 for nozzle coverage information.

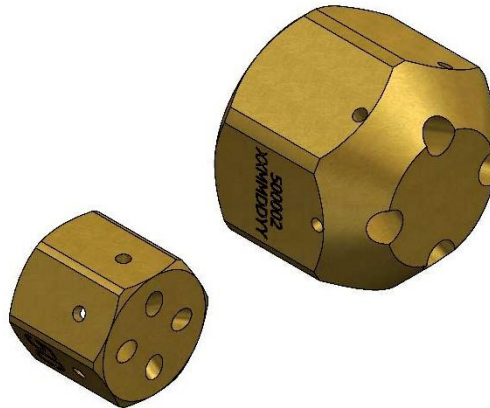
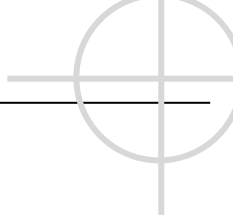


Figure 8 – Nozzles

Table 17 – Nozzle Part Numbers

Nozzle Part Number	Connection Size	Unit Assembly
500001	¼ in NPT	940202
500002	½ in NPT	940502/941002/942002



## 2.9 Pressure Switches

### 2.9.1 Valve Mounted Pressure Switch

The valve mounted pressure switch is an optional part of the unit assembly. It is factory installed into the pressure switch port of the cylinder valve. The valve mounted pressure switch is used to monitor unit pressure, unit actuation, or it can be used to energize or de-energize electrically operated equipment. If the unit to which the pressure switch is attached to loses pressure and reaches a pressure of  $135 \pm 10$  psig [ $9.3 \pm 0.7$  bar] or below, the switch contacts will operate. Refer to Figure 9 – Valve Mounted Pressure Switch, Table 18 – Valve Mounted Pressure Switch Part Number, Figure 10 – Valve Mounted Pressure Switch Wiring Schematic, and Table 19 – Pressure Switch Properties for additional information.

The pressure switch is single pole, double throw (SPDT) and can be wired in either the normally open (NO), normally closed (NC) configurations, where the normal condition is at atmospheric pressure. When the unit is pressurized, the contacts switch over.

When the pressure switch is used on a standard supervisory input circuit, there will be no distinction between a wiring fault and device actuation. The pressure switch shall be installed onto a circuit suitable for unit supervision in accordance with NFPA 70 National Electric Code and NFPA 72 National Fire Alarm and Signaling Code.

This device is only to be utilized when accepted by the authority having jurisdiction. All other uses of this switch should be approved by the authority having jurisdiction.

**NOTE: All detection devices and auxiliary alarm and control devices must be electrically compatible with each other. They must be approved by the authority having jurisdiction.**

**NOTE: Firetrace recommends that all units be equipped with a pressure switch and connected into a notification or shutdown device, in the event of a discharge.**

#### **CAUTION**

**Never use the pressure switch as a handle to transport the unit.**

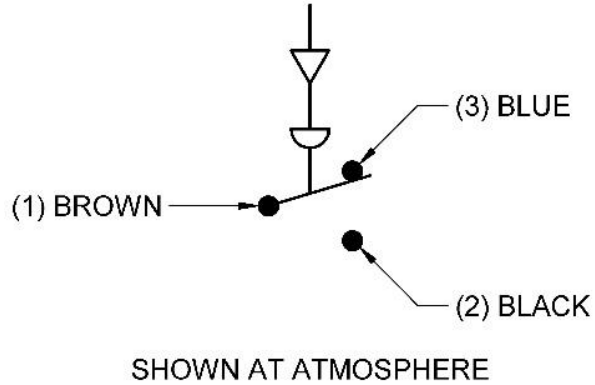


Figure 9 – Valve Mounted Pressure Switch



**Table 18 – Valve Mounted Pressure Switch Part Number**

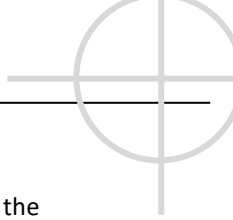
Pressure Switch Part Number	Description
400001	Valve Mounted Pressure Switch



**Figure 10 – Valve Mounted Pressure Switch Wiring Schematic**

**Table 19 – Pressure Switch Properties**

Electrical Rating		Temperature Range
28 VDC – 15 A		-20 °F to 150 °F [-28.9 °C to 65.6 °C]
NO (1 and 3): 120 VAC – 10 A 240 VAC – 5 A	NC (1 and 2): 120 VAC – 25 A 240 VAC – 5 A	



## 2.9.2 End of Line Pressure Switch

The end of line pressure switch is available as an optional part for the system detection network. The thread on the end of the pressure switch allows for easy installation into the threads of the end of line adapter. The provided washer ensures that the pressure switch will fully depress the Schrader core installed within the end of line adapter. The provided O-ring ensures that there will be an adequate seal between the pressure switch and the end of line adapter.

The end of line pressure switch is used to monitor system pressure, system discharge, or it can be used to energize or de-energize electrically operated equipment. If the detection network to which the pressure switch is attached to loses pressure and reaches a pressure of  $135 \pm 10$  psig [ $9.3 \pm 0.7$  bar] or below, the switch contacts will operate. Refer to Figure 11 – End of Line Pressure Switch, Table 20 – End of Line Pressure Switch Part Number, Figure 12 – End of Line Pressure Switch Wiring Schematic, and Table 21 – End of Line Pressure Switch Properties for additional information.

The pressure switch is single pole, double throw (SPDT) and can be wired in either the normally open (NO), normally closed (NC) configurations, where the normal condition is at atmospheric pressure. When the unit is pressurized, the contacts switch over.

When the pressure switch is used on a standard supervisory input circuit, there will be no distinction between a wiring fault and device actuation. The pressure switch shall be installed onto a circuit suitable for unit supervision in accordance with NFPA 70 National Electric Code and NFPA 72 National Fire Alarm and Signaling Code.

This device is only to be utilized when accepted by the authority having jurisdiction. All other uses of this switch should be approved by the authority having jurisdiction.

**NOTE: All detection devices and auxiliary alarm and control devices must be electrically compatible with each other. They must be approved by the authority having jurisdiction.**

**NOTE: Firetrace recommends that all units be equipped with a pressure switch and connected into a notification or shutdown device, in the event of a discharge.**

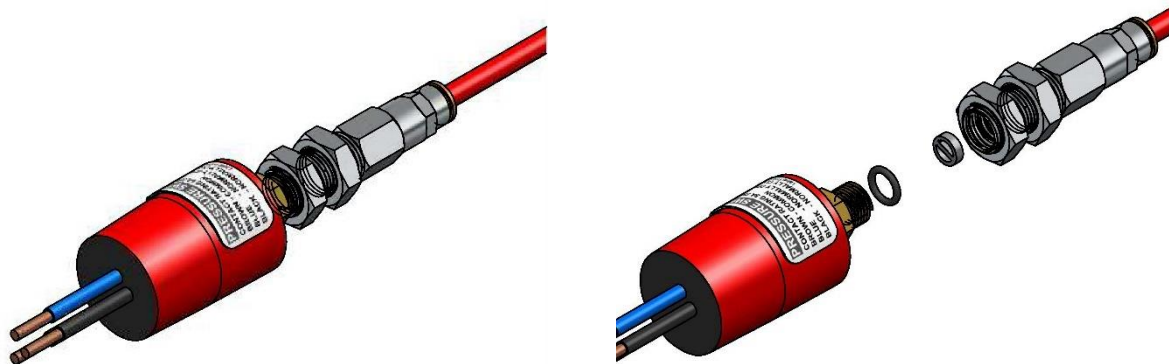
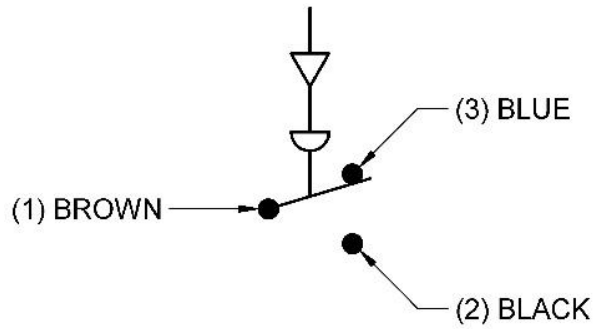


Figure 11 – End of Line Pressure Switch

**Table 20 – End of Line Pressure Switch Part Number**

Pressure Switch Part Number	Description
400004	End of Line Pressure Switch

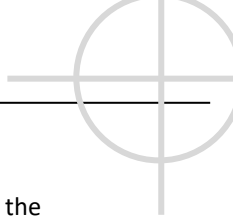


SHOWN AT ATMOSPHERE

**Figure 12 – End of Line Pressure Switch Wiring Schematic**

**Table 21 – End of Line Pressure Switch Properties**

Electrical Rating		Temperature Range
28 VDC – 15 A		-20 °F to 150 °F [-28.9 °C to 65.6 °C]
NO (1 and 3): 120 VAC – 10 A 240 VAC – 5 A	NC (1 and 2): 120 VAC – 25 A 240 VAC – 5 A	



### 2.9.3 Pressure Switch Assembly

The pressure switch assembly is available as an optional part for the system detection network. The fitting on the exterior of the pressure switch assembly enclosure allows for the detection tubing to be easily installed into the assembly.

The pressure switch assembly is used to monitor system pressure, system discharge, or it can be used to energize or de-energize electrically operated equipment. If the detection network to which the pressure switch is attached to loses pressure and reaches a pressure of  $135 \pm 10$  psig [ $9.3 \pm 0.7$  bar] or below, the switch contacts will operate. Refer to Figure 13 – Pressure Switch Assembly, Table 22 –Pressure Switch Assembly Part Number, Figure 14 – Pressure Switch Assembly Wiring Schematic, and Table 23 – Pressure Switch Assembly Properties for additional information.

The pressure switch is single pole, double throw (SPDT) and can be wired in either the normally open (NO), normally closed (NC) configurations, where the normal condition is at atmospheric pressure. When the unit is pressurized, the contacts switch over.

When the pressure switch is used on a standard supervisory input circuit, there will be no distinction between a wiring fault and device actuation. The pressure switch shall be installed onto a circuit suitable for unit supervision in accordance with NFPA 70 National Electric Code and NFPA 72 National Fire Alarm and Signaling Code.

This device is only to be utilized when accepted by the authority having jurisdiction. All other uses of this switch should be approved by the authority having jurisdiction.

**NOTE: All detection devices and auxiliary alarm and control devices must be electrically compatible with each other. They must be approved by the authority having jurisdiction.**

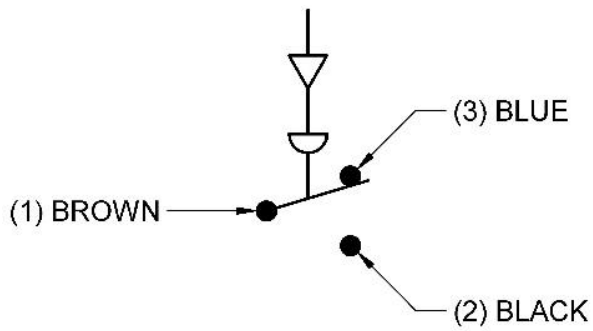
**NOTE: Firetrace recommends that all units be equipped with a pressure switch and connected into a notification or shutdown device, in the event of a discharge.**



Figure 13 – Pressure Switch Assembly

Table 22 –Pressure Switch Assembly Part Number

Pressure Switch Part Number	Description
400441	Pressure Switch Assembly



SHOWN AT ATMOSPHERE

Figure 14 – Pressure Switch Assembly Wiring Schematic

Table 23 – Pressure Switch Assembly Properties

Electrical Rating		Temperature Range
28 VDC – 15 A		-20 °F to 150 °F [-28.9 °C to 65.6 °C]
NO (1 and 3): 120 VAC – 10 A 240 VAC – 5 A	NC (1 and 2): 120 VAC – 25 A 240 VAC – 5 A	

NOTE: All detection devices and auxiliary alarm and control devices must be electrically compatible with each other. They must be approved by the authority having jurisdiction.

NOTE: Firetrace recommends that all units be equipped with a pressure switch and connected into a notification or shutdown device, in the event of a discharge.

---

## 2.10 Electric Solenoid Assembly

The electric solenoid assembly is available as an optional part for the system detection network. The fitting attached to the electric solenoid allows for the detection tubing to be easily installed into the electric solenoid assembly.

The electric solenoid assembly is used to release pressure from the detection tubing, resulting in actuation of the Firetrace ABC Powder ILP Unit. Refer to Figure 15 – Electric Solenoid Assembly, Table 24 – Electric Solenoid Assembly Part Number, Figure 16 – Electric Solenoid Assembly Wiring Schematic, and Table 25 – Electric Solenoid Assembly Properties for additional information.

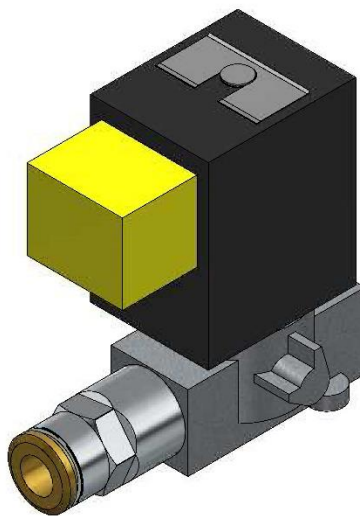
The electric solenoid is normally closed and requires electrical energy to remain open. The electric solenoid assembly is available in 12 VDC, 24 VDC, 120 VAC, and 240 VAC configurations.

The electric solenoid assembly shall be installed in accordance with NFPA 70 National Electric Code and NFPA 72 National Fire Alarm and Signaling Code.

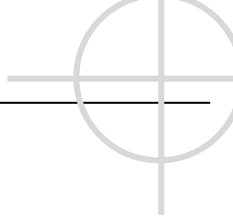
This device is only to be utilized when accepted by the authority having jurisdiction. All other uses of this electric solenoid assembly should be approved by the authority having jurisdiction.

**NOTE: All detection devices and auxiliary alarm and control devices must be electrically compatible with each other. They must be approved by the authority having jurisdiction.**

**NOTE: Detection networks equipped with an electric solenoid assembly, require the use of a solenoid connector cable.**

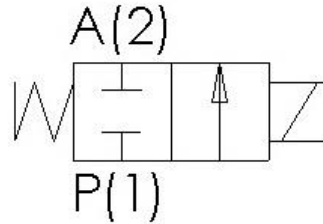


**Figure 15 – Electric Solenoid Assembly**



**Table 24 – Electric Solenoid Assembly Part Number**

Electric Solenoid Assembly Part Number	Description
400312**	12 VDC Electric Solenoid Assembly
400324**	24 VDC Electric Solenoid Assembly
400316**	120 VAC Electric Solenoid Assembly
400327**	240 VAC Electric Solenoid Assembly

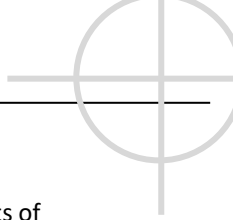


**Figure 16 – Electric Solenoid Assembly Wiring Schematic**

**Table 25 – Electric Solenoid Assembly Properties**

Maximum Allowable Pressure	725 psig [50 bar]
Opening Time	10 ms
Closing Time	10 ms
Fluid Temperature	32 °F to 266 °F [0 °C to 130 °C]

\*\* This is an optional component and is not part of an FM Approved System.



## 2.11 Indication and Activation Kit

The indication and activation kit is available as an optional part for the system detection network. The kit consists of a notification module and a system interface module. The notification module provides indication for “Fire/Activation” (Red LED and Audible Alarm), “Service” (Yellow LED), and “Power” (Green LED). The notification module can also be equipped with a system activation switch. The system interface module is equipped with a fitting that allows for the detection tubing to be easily installed into the system interface module.

When equipped with a system activation switch, the indication and activation kit is used to release pressure from the detection tubing, resulting in actuation of the Firetrace Novec 1230 ILP Unit. Refer to Figure 17 – Indication and Activation Kit and Table 26 – Indication and Activation Kit Part Number for additional information.

The indication and activation kit is available in 12 VDC or 24 VDC configurations.

**NOTE:** The indication and activation kit requires the use of a 2 amp fuse box. Fuse box is not included as part of the kit.

The indication and activation kit shall be installed in accordance with NFPA 70 National Electric Code and NFPA 72 National Fire Alarm and Signaling Code.

This device is only to be utilized when accepted by the authority having jurisdiction. All other uses of the indication and activation kit should be approved by the authority having jurisdiction.

**NOTE:** All detection devices and auxiliary alarm and control devices must be electrically compatible with each other. They must be approved by the authority having jurisdiction.

**NOTE:** Detection networks equipped with an indication and activation kit require the use of a 2 amp fuse box.

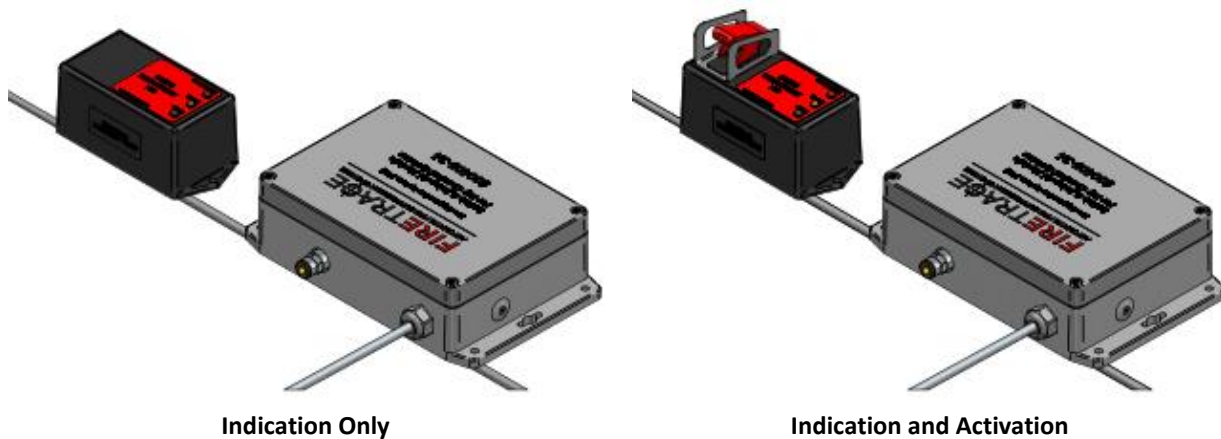
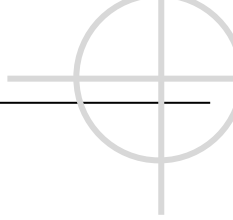


Figure 17 – Indication and Activation Kit



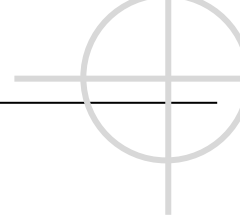


**Table 26 – Indication and Activation Kit Part Number**

<b>Indication and Activation Kit Part Number</b>	<b>Description</b>
600410-12 <sup>††</sup>	12 VDC Indication Kit, 195 psig, Bottom Cable
600420-12 <sup>††</sup>	12 VDC Indication and Activation Kit, 195 psig, Bottom Cable
600408-12 <sup>††</sup>	12 VDC Indication Kit, 195 psig, Rear Cable
600409-12 <sup>††</sup>	12 VDC Indication and Activation Kit, 195 psig, Rear Cable
600410-24 <sup>††</sup>	24 VDC Indication Kit, 195 psig, Bottom Cable
600420-24 <sup>††</sup>	24 VDC Indication and Activation Kit, 195 psig, Bottom Cable
600408-24 <sup>††</sup>	24 VDC Indication Kit, 195 psig, Rear Cable
600409-24 <sup>††</sup>	24 VDC Indication and Activation Kit, 195 psig, Rear Cable

---

<sup>††</sup> This is an optional component and is not part of an FM Approved System.



## Section 3: Design

### 3.1 Introduction

The Firetrace Pre-Engineered ABC Powder ILP Automatic Suppression Units design limitations were established and tested by Firetrace. The ILP units are Approved by FM Approvals.

These units were subjected to numerous performance and fire tests (as specified in FM 5320), in order to verify the suitability of the fire suppression units and to establish design limitations for the following parameters:

- Operating specifications
- Percentage of unclosable openings
- Discharge piping and fittings limitations
- Nozzle height
- Firetrace detection tubing limitations
- Enclosure size
- Discharge piping and fittings specifications
- Nozzle area coverage
- Nozzle placement
- Firetrace detection tubing placement

The Pre-Engineered concept minimizes the amount of engineering required when evaluating a design for a specific application. Provided that the discharge piping and nozzles are installed within the limits outlined in this manual, no calculations are required for pressure drop, flow rates, or discharge time. When the additional limitations (enclosure volume, area coverage, maximum height, design concentration, agent quantity, detection tubing placement) are also met, the system installation can be understood to comply with the design requirements, NFPA 17, and FM Approvals. Therefore, no discharge tests or concentration measurements should be required for evaluating a system design.

Systems shall be installed and maintained in accordance with NFPA 17, all applicable codes and regulations, and this manual. It is important that the limitations stated in this manual are followed.

**NOTE:** Firetrace Pre-Engineered ILP Automatic Suppression Units are designed and approved as an automatic unit. Firetrace ILP Units are not designed to provide simultaneous actuation of two or more units. Under the approval, only one Firetrace Pre-Engineered ILP Automatic Suppression Unit can be used to protect one enclosure, units shall not be combined to protect a larger enclosure.

#### **CAUTION**

Clean agent shall NOT be used on fires involving the following materials:

- Pyrotechnic chemicals containing their own oxygen supply.
- Reactive metals.
- Metal hydrides.
- Chemicals capable of undergoing autothermal decomposition.
- Deep seated or burrowing fires in ordinary combustible where point of combustion cannot be reached.

### 3.2 Operating Specifications

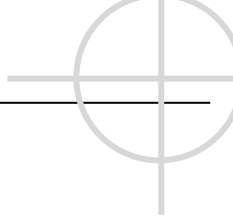
#### 3.2.1 Temperature Range

Firetrace Pre-Engineered ABC Powder ILP Automatic Suppression Units and equipment are designed to be stored and operated at the ambient temperature range of 0 °F to 130 °F [-17.8 °C to 54.4 °C].

#### 3.2.2 Operating Pressure

The normal operating pressure for Firetrace Pre-Engineered ABC Powder ILP Automatic Suppression Units is 195 psig at 70 °F [13.4 bar at 21.1 °C].

Firetrace Pre-Engineered ABC Powder ILP Automatic Suppression Units are designed for an operating temperature range of 0 °F to 130 °F [-17.8 °C to 54.4 °C]. Table 27 – Pressure-Temperature Relationship, shows the pressure gauge reading based on a charging pressure of 195 psig at 70 °F [13.4 bar at 21.1 °C].



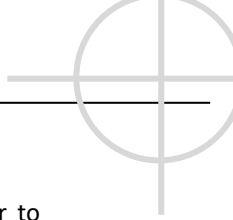
**Table 27 – Pressure-Temperature Relationship**

Temperature		Pressure	
°F	°C	psig	bar
0	-17.8	169	11.7
10	-12.2	173	11.9
20	-6.7	177	12.2
30	-1.1	180	12.4
40	4.4	184	12.7
50	10.0	188	13.0
60	15.5	191	13.2
70	21.1	195	13.4
80	26.7	199	13.7
90	32.2	202	13.9
100	37.8	206	14.2
110	43.3	210	14.5
120	48.9	213	14.7
130	54.4	217	15.0

### 3.3 Design Procedure

In addition to the applicable requirements specified in NFPA 17, the following steps should be used to design a system utilizing a Firetrace Pre-Engineered ABC Powder ILP Automatic Suppression Unit:

- a. Conduct a survey and analysis of the hazard to be protected.
- b. Determine the length, width, and height of the enclosure and calculate the volume. All of these parameters must be within the dimensional limitations specified in this manual.
- c. Determine the anticipated minimum and maximum ambient temperatures within the enclosure.
- d. Determine the minimum design concentration required for the hazard.
- e. Determine the integrity of the enclosure and if any openings must be closed at the time of agent discharge.
- f. Determine the cylinder size required, based on enclosure volume limitations and enclosure size.
- g. Determine the quantity of nozzles required, based on the size and configuration of the enclosure.
- h. Determine the location where the Firetrace ABC Powder ILP Unit and nozzles will be installed.
- i. Determine the routing and quantity of discharge piping required. Discharge piping and fittings used in the design must be within the limitations specified in this manual.
- j. Determine the arrangement and placement of the Firetrace detection tubing. Tubing parameters must be within the limitations specified in this manual.
- k. Determine any auxiliary equipment required to ensure proper protection of the enclosure.
- l. Prepare system drawings, bill of materials, and any additional documentation deemed necessary, following the applicable sections of NFPA 17.



### 3.4 Protected Enclosure

Firetrace Pre-Engineered ABC Powder Automatic Suppression Units are designed to enable a single cylinder to protect an enclosure of any size or shape, provided that the enclosure parameters do not exceed the limitations stated in the manual.

#### 3.4.1 Enclosure Size

The 940202 unit assembly is capable of protecting 75.3 ft<sup>3</sup> [2.13 m<sup>3</sup>] for every pound of agent. The 940502, 941002, and 942002 unit assemblies are capable of protecting 76.05 ft<sup>3</sup> [2.15 m<sup>3</sup>] for every pound of agent. Refer to Table 28 – Enclosure Size Limitations for Firetrace ABC Powder ILP Units for additional information.

**NOTE:** Firetrace Pre-Engineered ILP Automatic Suppression Units are designed and approved as an automatic unit. Firetrace ILP Units are not designed to provide simultaneous actuation of two or more units. Under the approval, only one Firetrace Pre-Engineered ILP Automatic Suppression Unit can be used to protect one enclosure, units shall not be combined to protect a larger enclosure.

**Table 28 – Enclosure Size Limitations for Firetrace ABC Powder ILP Units**

Unit Assembly	Max Area Coverage		Maximum Height		Maximum Total Volume Coverage	
	ft <sup>2</sup>	m <sup>2</sup>	ft	m	ft <sup>3</sup>	m <sup>3</sup>
940202	31.36	2.91	6	1.83	188.16	5.33
940502	42.25	3.93	9	2.74	380.25	10.77
941002	84.5	7.85	9	2.74	760.50	21.54
942002	169	15.7	9	2.74	1521	43.08

#### 3.4.2 Ventilation and Unclosable Openings

Openings in the protected enclosure must be sealed. When the unit is discharged into an enclosure, normal gaps and openings under doorways must not impact system performance. Doors and normal vents that are required in the enclosure must be closed prior to, or at the time of unit discharge. Doors or closures that normally swing to a closed position and are not held open do not require a system generated mechanism to operate. Doors and closures, including ventilation, which are held open while operating must have devices installed to close at the start or prior to unit discharge. All doors should be closed and ventilation fans shut down prior to discharge.

In the event of a discharge, the protected enclosure must have sufficient structural strength and integrity to contain the agent discharge. If the pressure difference across the enclosure boundaries presents a threat to the hazard enclosure, venting shall be provided to prevent excessive pressures.

#### 3.4.3 Unclosable Opening Percentage

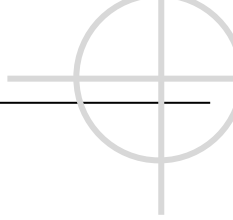
The total area of unclosable openings shall not exceed 1% of the total surface area of the enclosure. To calculate the unclosable opening percentage, the following equation should be used:

$$UO = \frac{A_{TS}}{A_{UO}} * 100$$

where: UO = unclosable opening percentage

A<sub>TS</sub> = total surface area (ft<sup>2</sup>)

A<sub>UO</sub> = total unclosable openings area (ft<sup>2</sup>)



## 3.5 Discharge Network

### 3.5.1 Discharge Piping and Pipe Fitting Specifications

All Firetrace Pre-Engineered ABC Powder ILP Automatic Suppression Units shall use copper tubing for the agent distribution system. See Table 29 – Discharge Piping Specifications and Table 30 – Discharge Pipe Fitting Specifications for specifications of the discharge piping and pipe fittings to be used with Firetrace ABC Powder ILP Units. Refer to NFPA 17 for alternate discharge network options.

**Table 29 – Discharge Piping Specifications**

Unit Assembly	Material	Outer Diameter	Wall Thickness
940202	soft annealed copper (AS B-280*) (for air conditioning and refrigeration service)	5/16 in	.032 in
940502		1/2 in	.032 in
941002		1/2 in	.032 in
942002		1/2 in	.032 in

\*The use of AS B-280 soft annealed copper, as specified in this manual, complies with ASME B 31.1 requirements of NFPA 2001.

**Table 30 – Discharge Pipe Fitting Specifications**

Material	Connection Type	Minimum Pressure Rating**
Brass	Flareless Bite*	1000 psig

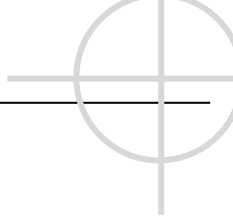
\*Use Parker Intru-Lok, Camozzi, or equivalent  
\*\*Minimum pressure rating for use with Firetrace ABC Powder ILP Units

### 3.5.2 Discharge Piping and Pipe Fitting Limitations

Changes in direction of flow can result in separation of the expellant gas and the ABC Powder. To provide proper distribution of the ABC Powder upon splitting the stream, special attention must be given to the method in which an approach is made to a tee after a change in direction. Refer to Table 31 – Discharge Piping Limitations, Figure 18 – Typical Tee Fitting Configuration Guideline and Table 32 – Pipe Fitting Limitations for more information.

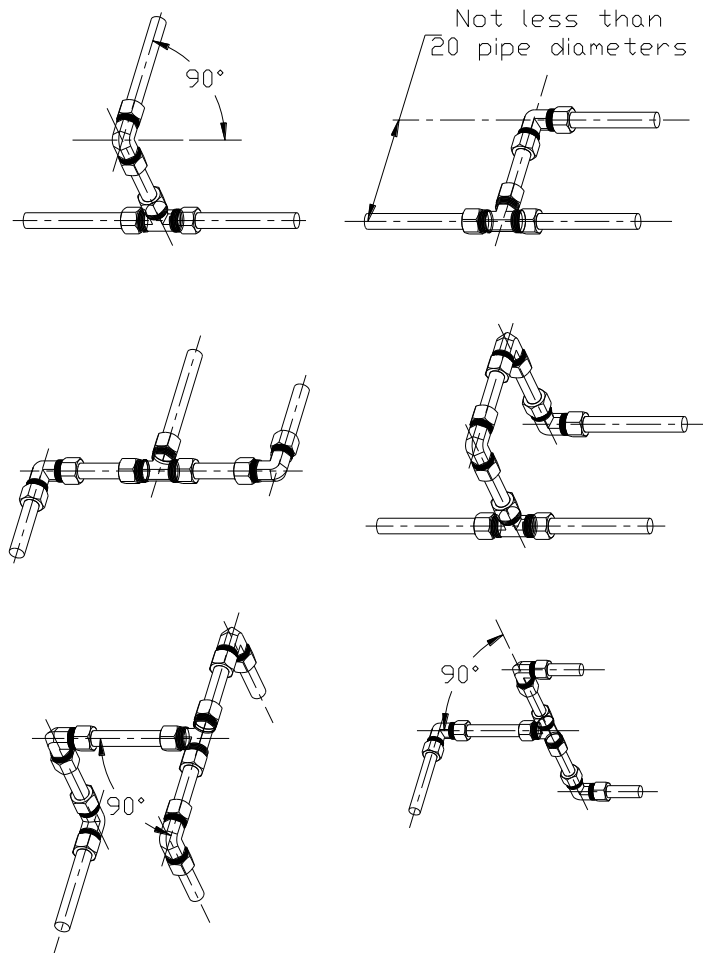
**Table 31 – Discharge Piping Limitations**

Unit Assembly	Discharge Ports Used	Nozzles per Discharge Port	Total Nozzles Used	Maximum Length of Discharge Piping	
				ft	m
940202	1	1	1	7	2.13
	2	1	2	7	2.13
	2	2	4	7	2.13
940502	1	1	1	10	3.05
	2	1	2	10	3.05
	2	2	4	15	4.57
941002	2	1	2	10	3.05
	2	2	4	15	4.57
942002	2	1	2	10	3.05
	2	2	4	15	4.57

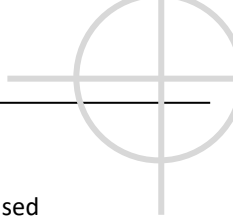


**Table 32 – Pipe Fitting Limitations**

Unit Assembly	Discharge Ports Used	Nozzles per Discharge Port	Total Nozzles Used	Maximum Elbows per Discharge Port	Maximum Tees per Discharge Port
940202	1	1	1	1	0
	2	1	2	1	0
	2	2	4	3	1
940502	1	1	1	2	0
	2	1	2	2	0
	2	2	4	3	1
941002	2	1	2	2	0
	2	2	4	3	1
942002	2	1	2	2	0
	2	2	4	3	1



**Figure 18 – Typical Tee Fitting Configuration Guideline**



### 3.5.3 Discharge Pipe Bends

Wherever possible, pipe bends should be used in lieu of 90° elbows. It is recommended that a pipe bender be used when forming the 90° bends. Refer to Table 33 –Pipe Bend Radius and Equivalent Length when forming pipe bends, to minimize the chance of flattening the pipe.

**Table 33 –Pipe Bend Radius and Equivalent Length**

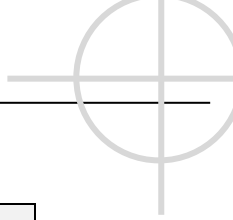
Pipe Outer Diameter (OD)	Minimum Bend Radius* to Pipe Centerline	Equivalent Length** for 90° Bend***
5/16 in	11/16 in	1-1/8 in
1/2 in	1-1/2 in	2-3/8 in

\* The minimum bend radii were derived from Parker Industrial Tube Fittings Catalogue 4300, dated March 1991.  
\*\* The equivalent length is to be subtracted from the maximum length of piping as stated under Table 31 – Discharge Piping Limitations.  
\*\*\*90° pipe bends are not required to be subtracted from the maximum number of elbows stated under Table 32 – Pipe Fitting Limitations.

### 3.5.4 Nozzle Area Coverage

The 940202 and 940502 unit assemblies can be installed using 1, 2, or 4 nozzles to suit the hazard configuration. The 941002 and 942002 unit assemblies can be designed using 2 or 4 nozzles to suit the hazard configuration. Table 34 – Nozzle Area Coverage Limitations below shows the nozzle area coverage limitations for Firetrace Pre-Engineered ABC Powder ILP Automatic Suppression Units. The maximum enclosure height for nozzle installation is 6 ft [1.83 m] for the 940202 unit assembly. The maximum enclosure height for nozzle installation is 9 ft [2.74 m] for the 940502, 941002, and 942002 unit assemblies.

Each Firetrace ILP unit is equipped with two discharge ports, whether one or both discharge ports are used is dependent on the size and shape of the enclosure, and the number of nozzles required to cover the protected hazard. See Figure 19 – Typical Nozzle Configuration Guideline for typical examples of configurations that meet the stated limitations.



**Table 34 – Nozzle Area Coverage Limitations**

Unit Assembly	Discharge Ports Used	Nozzles per Discharge Port	Total Nozzles Used	Maximum Area Coverage per Nozzle		Total Area Coverage per Unit Assembly	
						ft <sup>2</sup>	m <sup>2</sup>
940202	1	1	1	5.6 ft x 5.6 ft 31.36 ft <sup>2</sup>	1.71 m x 1.71 m 2.91 m <sup>2</sup>	31.36	2.91
	2	1	2	5.6 ft x 2.8 ft 15.68 ft <sup>2</sup>	1.71 m x 0.86 m 1.46 m <sup>2</sup>	31.36	2.91
	2	2	4	2.8 ft x 2.8 ft 7.84 ft <sup>2</sup>	0.86 m x 0.86 m 0.73 m <sup>2</sup>	31.36	2.91
940502	1	1	1	6.5 ft x 6.5 ft 42.25 ft <sup>2</sup>	1.98 m x 1.98 m 3.93 m <sup>2</sup>	42.25	3.93
	2	1	2	6.5 ft x 3.25 ft 21.125 ft <sup>2</sup>	1.98 m x 0.99 m 1.96 m <sup>2</sup>	42.25	3.93
	2	2	4	3.25 ft x 3.25 ft 10.56 ft <sup>2</sup>	0.99 m x 0.99 m 0.98 m <sup>2</sup>	42.25	3.93
941002	2	1	2	6.5 ft x 6.5 ft 42.25 ft <sup>2</sup>	1.98 m x 1.98 m 3.93 m <sup>2</sup>	84.5	7.85
	2	2	4	6.5 ft x 3.25 ft 21.125 ft <sup>2</sup>	1.98 m x 0.99 m 1.96 m <sup>2</sup>	84.5	7.85
942002	2	1	2	6.5 ft x 6.5 ft 42.25 ft <sup>2</sup>	1.98 m x 1.98 m 3.93 m <sup>2</sup>	84.5	7.85
	2	2	4	6.5 ft x 6.5 ft 42.25 ft <sup>2</sup>	1.98 m x 1.98 m 3.93 m <sup>2</sup>	169	15.7



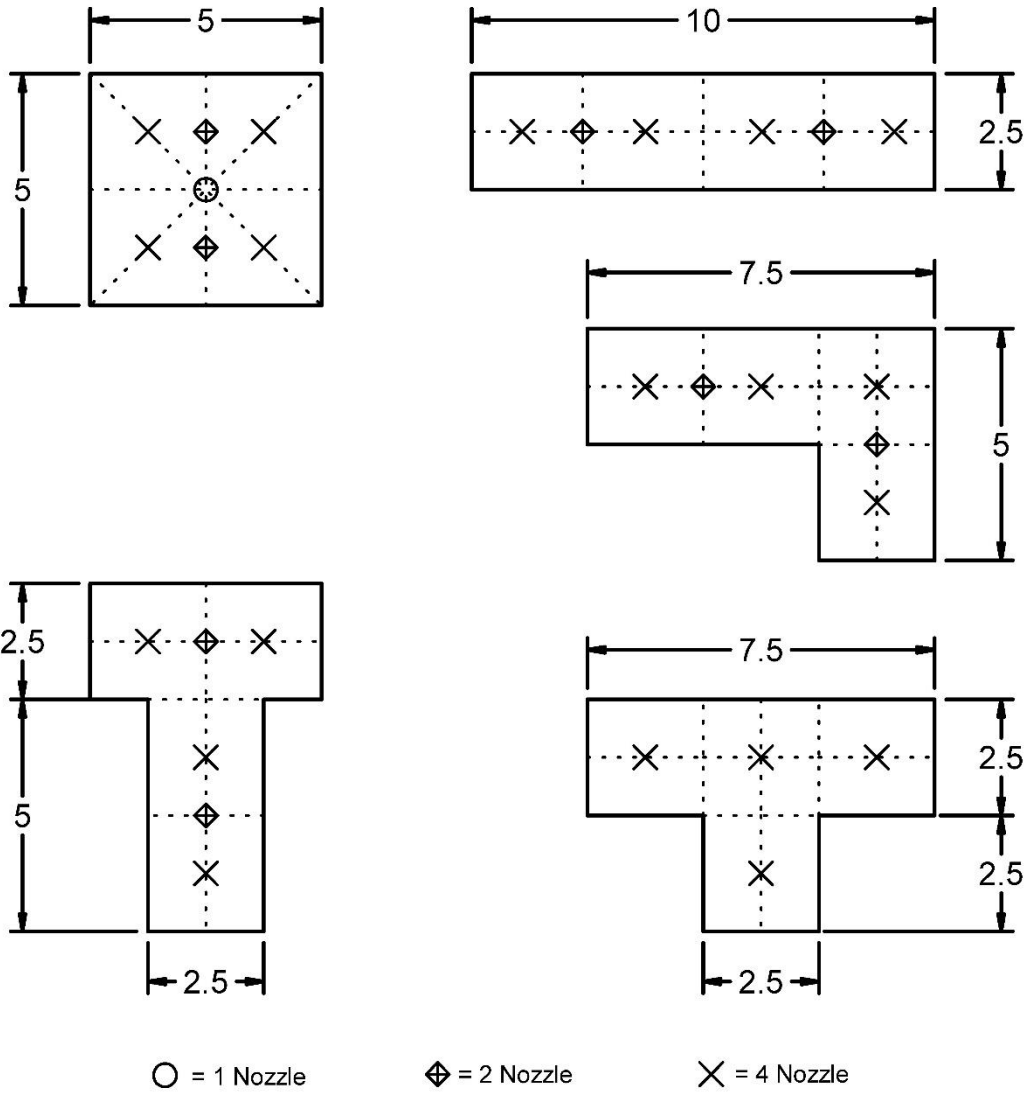
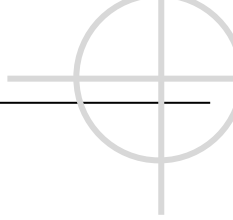
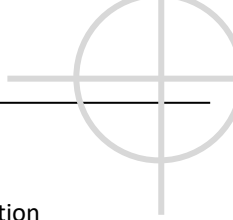


Figure 19 – Typical Nozzle Configuration Guideline



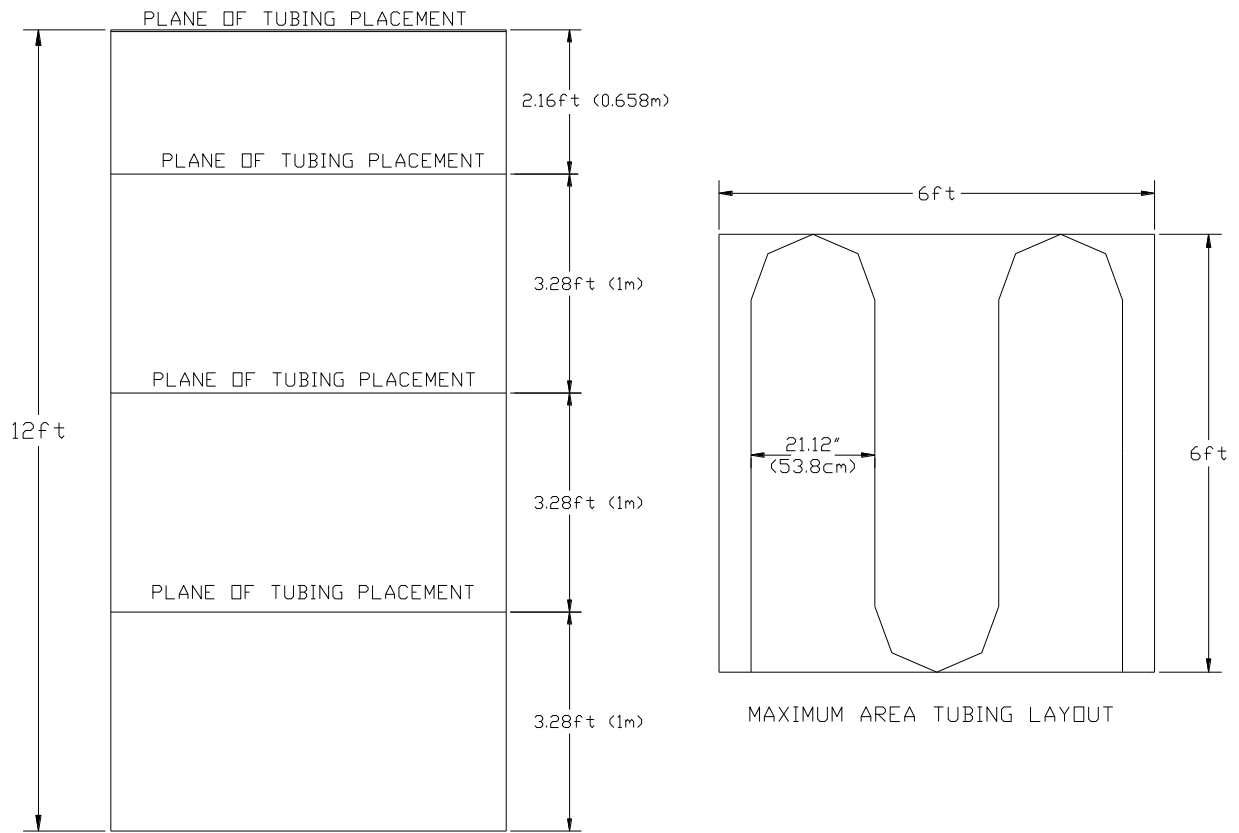
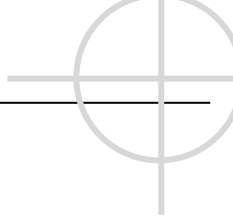
### 3.6 Firetrace Detection Tubing

Location of the Firetrace detection tubing is critical to the response time in the event of a fire. The Firetrace detection tubing should be installed throughout the enclosure and routed in close proximity to all potential fire sources. The Firetrace detection tubing should not be placed horizontally adjacent to a potential fire source.

In order to protect the overall height of a protected enclosure, the tubing must be installed in height increments of 3.28 ft [1 m]. In order to protect the overall area of a protected enclosure, the tubing must be installed in passes. The maximum distance between passes is 21.12 in [53.8 cm]. The maximum distance allowed from any wall to the tubing is 10.56 in [26.82 cm]. The minimum bend radius shall not exceed 6 in [15.24 cm]. The maximum length of Firetrace detection tubing that can be used for Firetrace ABC Powder ILP Units is 120 ft [36.58m]. Refer to Table 35 – Firetrace Detection Tubing Limitations and Figure 20 – Tubing Configuration Guideline below for Firetrace detection tubing limitations and a guideline for typical tubing configurations.

**Table 35 – Firetrace Detection Tubing Limitations**

Description	Limitation	
Maximum length	120 ft	36.58 m
Maximum height between layers	3.28 ft	1 m
Maximum distance between passes	21.12 in	53.8 cm
Maximum distance from wall	10.56 in	26.82 cm
Minimum bend radius	6 in	15.24 cm



MAXIMUM HEIGHT TUBING LAYOUT

**Side View**

**Top View**

**Figure 20 – Tubing Configuration Guideline**

---



## Section 4: Installation

### 4.1 Introduction

This section provides installation instructions for components and limitations described in Section 2 and Section 3 of this manual. All components should be installed to facilitate proper inspection, testing, recharging, and any other required service or maintenance, as may be necessary. Equipment must not be subjected to severe weather conditions, mechanical damage, chemical damage, or other damage which could render the equipment inoperative.

Firetrace Pre-Engineered ABC Powder ILP Suppression Units and equipment must be handled, installed, and serviced only by qualified and trained personnel, in accordance with the instructions contained in this manual and on the cylinder nameplate, as well as NFPA 17, FM 5320, and any other regulations and codes that may apply.

### 4.2 Firetrace ABC Powder ILP Unit

#### **WARNING**

**Ensure the ball valve, located on the top of the cylinder valve, is maintained in the “OFF” position. Ensure that the discharge port plugs are installed until the unit is mounted and ready for connection to the discharge piping.**

The Firetrace ABC Powder ILP Unit should be located as close as possible to the protected enclosure. In some cases, the unit can be mounted inside the protected enclosure. The unit shall be located in a readily accessible location to allow for ease of inspection, service, and maintenance. The unit shall be located in an environment protected from the weather and where the temperature range is between 0 °F to 130 °F [-17.8 °C to 54.4 °C].

The cylinder and bracket must be mounted in the vertical plane with the cylinder valve on top, and oriented so that the pressure gauge is facing out and away from the mounting wall to facilitate visual inspection.

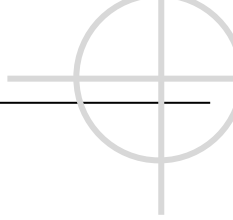
Mount the cylinder where it will not be subjected to accidental damage or movement. Suitable protection must be installed, where necessary, to prevent damage or movement.

The steps below should be followed to ensure proper installation of the Firetrace ABC Powder ILP Unit:

1. Install the cylinder mounting bracket to a structural support using two or more mounting holes.
2. Agitate the ABC Powder by carefully inverting the unit assembly and gently knocking on the bottom and sides of the cylinder with a rubber mallet. Knock with a rubber mallet 5 to 10 times to ensure proper agitation.
3. Verify the unit pressure is within the operable range.
4. Position the cylinder in the bracket with the pressure gauge facing out.
5. Secure the cylinder in place using the bracket straps or band clamps.

#### **WARNING**

**Pressurized (charged) cylinders are extremely hazardous and if not handled properly are capable of causing property damage, bodily injury, or death. Always wear safety glasses and ensure the discharge port plugs are properly installed before installing, servicing, or other general handling of ILP Units.**



## 4.3 Discharge Network

The steps below should be followed to ensure proper installation of the discharge network:

1. Following the guidelines and limitations outlined in Section 3.6, determine whether one or two discharge ports will be used. If two discharge ports are to be used, verify that the pipe length from each discharge port does not exceed a 10% imbalance.
2. Following the guidelines and limitations outlined in Section 3, determine whether one, two, or four nozzles will be used and install the nozzles.
3. Remove the discharge port plug(s), as required, and install male connection fittings in the discharge port(s), as required.
4. Install the discharge piping and fittings between the discharge port(s) and nozzle(s). Secure the discharge network with the appropriate clamps, as required.

## 4.4 Detection Network

### 4.4.1 Firetrace Detection Tubing

Location and spacing of the tubing is critical to the response time in the event of a fire. The tubing should be placed above the hazard areas being protected. In addition to the guidelines and limitations outlined in Section 3.6, the steps below should be followed to ensure proper installation of the detection network:

1. Secure the Firetrace detection tubing by using mounting tabs. The mounting tabs should be placed at 1.5 ft [0.46 m] intervals.
2. Use the appropriate rubber/plastic grommets when the detection tubing is routed through sharp holes in order to prevent damage to the tubing.

**NOTE: Do not kink, bend, or crush Firetrace detection tubing. Damage to the tubing can result in leakage and/or accidental discharge of the Firetrace ABC Powder ILP Unit.**

**NOTE: Do not install tubing in extreme environments where the maximum ambient temperature exceeds 176 °F [80 °C].**

### 4.4.2 Tube Fittings

All detection tube fittings must be secured in the following manner:

1. Cut the tube end, ensuring the cut is clean, square, and free from burrs.
2. Thoroughly clean the tubing, starting from the cut end, to approximately 2 in [5.08 cm] from the cut end. Remove all dirt, grease, or grime and ensure no debris is left in the tube. This will ensure a proper seal inside the fitting.
3. Slide the tubing into the opening of the fitting, until it reaches the inner wall.
4. Lightly pull on the tubing. The brass outer ring should move outward slightly.

### 4.4.3 End of Line Accessories

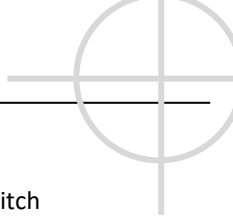
The end of line adapter is used to install auxiliary accessories to the detection network. One end of the end of line adapter contains a tube fitting. Install the end of line adapter to the end of the Firetrace detection tubing using the instructions outlined in Section 4.4.2.

**NOTE: End of line Adapters are not designed to provide a lasting seal without the use of auxiliary accessories.**

#### 4.4.3.1 Pressure Gauge

Verify that the threaded connection of the pressure gauge contains a lubricated O-ring. The pressure gauge is then installed into the inner threads of the end of line adapter. Hand tighten until the O-ring is completely inside.

**NOTE: The pressure gauge must be installed with its included O-ring to ensure a proper seal.**



---

#### 4.4.3.2 Pressure Switch

Verify that the threaded connection of the pressure switch contains a lubricated O-ring. Insert the pressure switch washer into the inner threads of the end of line adapter. Install the pressure switch into the inner threads of the end of line adapter. Hand tighten until an audible “click” can be heard.

**NOTE: The pressure switch washer must be installed into the inner threads of the end of line adapter. Without properly installing the pressure switch washer, the pressure switch will not be active.**

**NOTE: The pressure switch must be installed with its included O-ring to ensure a proper seal.**

#### 4.4.3.3 Plug

Verify that that threaded connection of the plug contains a lubricated O-ring. Install the plug into the inner threads of the end of line adapter. Hand tighten until the O-ring is completely inside.

**NOTE: The plug must be installed with its included O-ring to ensure a proper seal.**

---



## Section 5: Operation

### 5.1 System Activation

#### **WARNING**

Ensure the ball valve, located on the top of the cylinder valve, is maintained in the “OFF” position.

The steps below should be followed to ensure proper system activation of the Firetrace ABC Powder ILP Unit:

1. Install the detection tubing throughout the enclosure. Ensure all necessary fittings and accessories are installed in accordance with the procedures specified in Section 4.
2. With the unit ball valve in the closed position, thread the tube fitting into the ball valve attached to the top of the cylinder valve.
3. Install one end of the Firetrace detection tubing into the fitting in accordance with the procedures specified in Section 4.
4. Ensure the end of line adapter is installed in the opposite end of the detection tubing. Verify no accessories are installed in the end of line adapter.
5. Attach the filling adapter into the end of line adapter.
6. Attach a regulated nitrogen supply onto the filling adapter.
7. Pressurize the detection tubing to 195 psig [13.4 bar].
8. Remove the nitrogen supply and filling adapter from the end of line adapter.
9. Thread the pressure gauge into the end of line adapter and verify that the tubing is pressurized to at least 195 psig at 70 °F [13.4 bar at 21.1 °C]. (Pressure may have to be adjusted for temperatures higher or lower than 70 °F [21.1 °C]).
10. With the gauge still installed in the end of line adapter, test for leakage:
  - a) Apply a soapy water solution to the cylinder valve connection, end of line adapter connection, and the pressure gauge connection.
  - b) Observe for bubble leaks.
  - c) After approximately 30 minutes, verify the pressure gauge reading. Any decrease in pressure is an indication of a leak. If the system is determined to contain a leak, refer to Section 4 and verify that installation procedures were properly followed for all fittings and accessories.
11. If the end of line pressure switch is to be installed, remove the pressure gauge from the end of line adapter and install the end of line pressure switch in accordance with the procedures specified in Section 4.
12. After confirming that there is no leakage within the detection tubing, SLOWLY rotate the ball valve lever counter clockwise, to the “ON” position.
13. Tamperproof the Firetrace ABC Powder ILP Unit by removing the ball valve lever face and securing the ball valve lever in the “ON” position with the tamperproof device.
14. If a pressure switch is installed on the system or on the end of line adapter, ensure the proper electrical connections are made, in accordance with NFPA 70 National Electric Code, NFPA 72 National Fire Alarm and Signaling Code, and any other applicable codes and regulations that may apply.
15. The Firetrace Pre-Engineered ABC Powder ILP Automatic Suppression Unit is now ready for use.

**NOTE:** All detection devices and auxiliary alarm and control devices must be electrically compatible with each other. They must be approved by the authority having jurisdiction.

#### **WARNING**

Only open the ball valve AFTER the tubing has been pressurized. Opening the ball valve without pressurizing the tubing may cause actuation of the unit, resulting in system discharge.

#### **WARNING**

Ball valve must SLOWLY be opened. Opening the ball valve abruptly, may cause actuation of the unit, resulting in system discharge.

---



## Section 6: Maintenance

### 6.1 General

Firetrace Pre-Engineered ABC Powder ILP Automatic Suppression Units must be handled, installed, inspected, and serviced only by qualified and trained personnel in accordance with the instructions contained in this manual, cylinder nameplates, NFPA 2001, FM 5600, and any other codes and regulations that may apply.

A regular program of systematic maintenance must be established for continuous, proper operation of all Firetrace ABC Powder ILP units. A periodic maintenance schedule must be followed and an inspection log maintained. At a minimum, the log must record: (1) inspection interval, (2) inspection procedure performed, (3) maintenance performed, if any, as a result of inspection, and (4) name of inspector performing task.

For any deficiencies that are found, appropriate corrective actions shall be taken immediately.

**NOTE:** Any maintenance requiring depressurization, filling, or pressurization shall only be performed at an authorized Firetrace service location. Service at any other location will void any warranty. Please contact Firetrace directly for a list of authorized Firetrace service locations.

#### **WARNING**

Pressurized (charged) cylinders are extremely hazardous and if not handled properly are capable of causing property damage, bodily injury, or death. Always wear safety glasses and ensure the discharge port plugs are properly installed before installing, servicing, or other general handling of ILP Units.

### 6.2 Maintenance Schedule

#### 6.2.1 Monthly

The following are to be performed on a monthly basis by the owner or designated personnel:

1. Verify the Firetrace ABC Powder ILP Unit is in its proper location.
2. Verify the tamperproof device is intact.
3. Confirm the maintenance tag or certificate is in its proper location.
4. Verify that the Firetrace ABC Powder ILP Unit shows no physical damage or degradation that might prevent operation.
5. Verify the pressure gauge is in the operable range.
6. Verify nozzle blow off caps (if used) are intact and undamaged.
7. Verify the protected equipment and hazard has not been replaced, modified, or relocated.
8. If a pressure switch is installed:
  - a) Check connection for any leakage.
  - b) Verify the proper electrical connections are made.

**NOTE:** All electrical connections are to be in accordance with NFPA 70 National Electric Code and NFPA 72 National Fire Alarm and Signaling Code, and any other applicable codes and regulations.

**NOTE:** This system consists of components tested within limitations contained in this manual. The designer of this system must be consulted prior to any planned changes to either the system or the area being protected. An authorized Firetrace distributor must be consulted after the system has discharged.

**NOTE:** Firetrace recommends replacement of the tubing at various intervals, depending on the application and exposure.



## 6.2.2 Semi-Annual

The semi-annual maintenance is to be performed by an authorized Firetrace distributor. Maintenance should include a repetition of the monthly maintenance as well as verification of the Firetrace ABC Powder ILP Unit weight. Additionally, the ABC Powder should be agitated. The Firetrace ABC Powder ILP unit weight should be verified using the following steps:

1. Remove the tamperproof device from the ball valve lever.
2. Rotate the ball valve lever clockwise, to the "OFF" position.
3. Depressurize the Firetrace detection tubing:
  - a) Remove accessory installed into the end of line adapter.
  - b) Attach the filling adapter into the end of line adapter.
4. Remove the Firetrace detection tubing from the tube fitting attached to the top of the cylinder valve.
5. Remove the discharge piping from the discharge outlet ports.
6. Install the discharge outlet port plugs into both discharge outlet ports.
7. Remove the cylinder from the cylinder mounting bracket.
8. Weigh the Firetrace ABC Powder ILP Unit.
  - a) Compare the measured weight with the weight specified on the cylinder labels. If the Firetrace ABC Powder ILP Unit shows a loss in agent quantity of more than 5 percent, the unit shall be refilled or replaced.
9. Carefully invert the unit assembly and gently knock on the bottom and sides of the cylinder with a rubber mallet approximately 5 to 10 times.
10. Verify pressure reading on the pressure gauge installed to the Firetrace ABC Powder ILP Unit.
  - a) If the Firetrace ABC Powder ILP Unit shows a pressure loss (adjusted for temperature) of more than 10 percent, the unit shall be refilled or replaced.
11. Reinstall the Firetrace ABC Powder ILP Unit and pressurize the detection tubing, see Section 4 and Section 5 for instructions.

**NOTE:** This system consists of components tested within limitations contained in this manual. The designer of this system must be consulted prior to any planned changes to either the system or the area being protected. An authorized Firetrace distributor must be consulted after the system has discharged.

**NOTE:** Any maintenance requiring depressurization, filling, or pressurization shall only be performed at an authorized Firetrace service location. Service at any other location will void any warranty. Please contact Firetrace directly for a list of authorized Firetrace service locations.

### **WARNING**

Only depressurize tubing **AFTER** the ball valve has been closed. Depressurizing the tubing without closing the ball valve may cause actuation of the unit, resulting in system discharge.

### **WARNING**

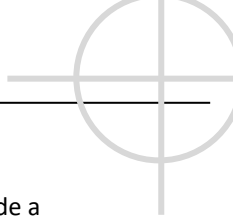
Only open the ball valve **AFTER** the tubing has been pressurized. Opening the ball valve without pressurizing the tubing may cause actuation of the unit, resulting in system discharge.

### **WARNING**

Ball valve must **SLOWLY** be opened. Opening the ball valve abruptly, may cause actuation of the unit, resulting in system discharge.

### **WARNING**

Pressurized (charged) cylinders are extremely hazardous and if not handled properly are capable of causing property damage, bodily injury, or death. Always wear safety glasses and ensure the discharge port plugs are properly installed before installing, servicing, or other general handling of ILP Units.



### 6.2.3 Five-Year

The five-year maintenance is to be performed by an authorized Firetrace distributor. Maintenance should include a repetition of the monthly and semi-annual maintenance, a complete external visual inspection of the cylinder, per the guidelines detailed in Section 7 of NFPA 2001, and evaluation of the Firetrace detection tubing for damage and pliability.

**NOTE:** Any maintenance requiring depressurization, filling, or pressurization shall only be performed at an authorized Firetrace service location. Service at any other location will void any warranty. Please contact Firetrace directly for a list of authorized Firetrace service locations.

## 6.3 Firetrace Detection Tubing Maintenance

Firetrace detection tubing maintenance is to be performed by an authorized Firetrace distributor. Maintenance should include a complete external visual inspection of the tubing during every monthly inspection. The tubing shall show no signs of physical damage or degradation, including but not limited to abrasion, distortion, cuts, dirt accumulation. For any deficiencies that are found, appropriate corrective actions shall be taken immediately.

In addition to a monthly visual inspection, a five-year inspection is to be performed to evaluate the tubing for damage and pliability. If any concerns are noted, replacement of the Firetrace detection tubing would be recommended.

After 10 years of continuous use, the Firetrace detection tubing should be replaced in its entirety. However, if all routine maintenance is followed and inspection of the tubing determines the tubing to be in good condition and does not show signs of damage or degradation, the tubing can remain in service.

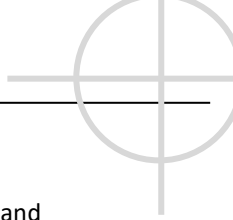
**NOTE:** If a fire situation is experienced, any sections of tubing that have ruptured or have been damaged during a fire must be replaced. Sections can be replaced by splice connections.

#### **WARNING**

To prevent accidental actuation of the unit, only inspect tubing AFTER the ball valve has been closed. Once inspection is complete, ensure tubing is pressurized.

#### **WARNING**

Pressurized (charged) cylinders are extremely hazardous and if not handled properly are capable of causing property damage, bodily injury, or death. Always wear safety glasses and ensure the discharge port plugs are properly installed before installing, servicing, or other general handling of ILP Units.



## 6.4 ABC Powder Maintenance

Maintenance of the ABC Powder is to be performed by an authorized Firetrace distributor. Prior to installation and during every semi-annual inspection the ABC Powder should be agitated using a rubber mallet. Additionally, at least once every 6 years the ABC Powder should be examined for caking. If any concerns are noted, replacement of the ABC Powder would be recommended. The following steps should be followed when agitating the ABC Powder:

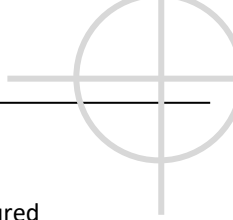
1. Remove the tamperproof device from the ball valve lever.
2. Rotate the ball valve lever clockwise, to the "OFF" position.
3. Depressurize the Firetrace detection tubing:
  - c) Remove accessory installed into the end of line adapter.
  - d) Attach the filling adapter into the end of line adapter.
4. Remove the Firetrace detection tubing from the tube fitting attached to the top of the cylinder valve.
5. Remove the discharge piping from the discharge outlet ports.
6. Install the discharge outlet port plugs into both discharge outlet ports.
7. Remove the cylinder from the cylinder mounting bracket.
8. Carefully invert the unit assembly and gently knock on the bottom and sides of the cylinder with a rubber mallet approximately 5 to 10 times.

### **WARNING**

Unit should only be agitated AFTER the ball valve has been closed, the tubing depressurized, and the discharge port plugs installed into the discharge ports. Agitating without following these steps may cause actuation of the unit, resulting in system discharge.

### **WARNING**

Pressurized (charged) cylinders are extremely hazardous and if not handled properly are capable of causing property damage, bodily injury, or death. Always wear safety glasses and ensure the discharge port plugs are properly installed before installing, servicing, or other general handling of ILP Units.



## 6.5 Cylinder Maintenance

Firetrace Pre-Engineered ABC Powder ILP Automatic Suppression Units are assembled with cylinders manufactured to DOT-4B specifications, and therefore fall under DOT regulations for retest, prior to any refilling procedures.

Under DOT regulations, cylinders manufactured to DOT-4B specifications are required to be hydrostatically tested and stamped prior to recharge and shipment, if the last hydrostatic test date has expired.

Cylinders requiring hydrostatic testing must be tested in accordance with 49 CFR 173.34. The periodic hydrostatic test must be performed by an authorized tester, having a current identification number issued by the Associated Administrator for Hazardous Material Safety of DOT. The periodic hydrostatic test must also include an internal and external examination, in accordance with CGA pamphlet C-6, C-6.1, C-6.2, and C-6.3, as applicable. The periodic hydrostatic test procedures also require measurement of the volumetric expansion of the container. As a result, only the water jacket volumetric expansion method or the direct expansion method are acceptable.

As an alternate to the periodic hydrostatic test, cylinders may be given a complete external visual inspection, in accordance with 49 CFR 173.34(e)(13). The visual inspection shall be made only by competent persons. A person who performs the visual examination specified in 49 CFR 173.34(e)(13) is not required to have an identification number issued by the Associated Administrator for Hazardous Material Safety of DOT.

Table 36 – Cylinder Maintenance below outlines the testing that can be performed to meet DOT regulations.

**Table 36 – Cylinder Maintenance**

Test Method	First Test Due	Subsequent Test Due	Special Marking
Full hydrostatic test. Including determination of cylinder expansion.	5 years	5 years	Test Date Month/Year
External visual inspection per 49 CFR 173.34(e)(13) AND CGA pamphlet C-6, Section 3.	5 years	5 years	Test date Month/Year followed by "E"

---



## Section 7: Recharge

### 7.1 General

Firetrace Pre-Engineered ABC Powder ILP Automatic Suppression Units must be handled, installed, inspected, and serviced only by qualified and trained personnel in accordance with the instructions contained in this manual, cylinder nameplates, NFPA 17, FM 5320, and any other codes and regulations that may apply.

**NOTE:** Any maintenance requiring depressurization, filling, or pressurization shall only be performed at an authorized Firetrace service location. Service at any other location will void any warranty. Please contact Firetrace directly for a list of authorized Firetrace service locations.

#### **WARNING**

Pressurized (charged) cylinders are extremely hazardous and if not handled properly are capable of causing property damage, bodily injury, or death. Always wear safety glasses and ensure the discharge port plugs are properly installed before installing, servicing, or other general handling of ILP Units.

### 7.2 Recharge

The steps below should be followed to ensure proper recharge of an empty Firetrace ABC Powder ILP Unit:

1. Fill the cylinder with the appropriate amount of agent. Refer to Table 2, for correct agent amount.
2. Clean the threads of the cylinder with a small brush or dry cloth.
3. Thread the siphon tube into the bottom of the valve.
4. Insert bottom end of siphon tube into the cylinder, and thread the valve into the cylinder.
5. With the discharge port plugs in place, use the ball valve attached to the top of the valve to pressurize the Firetrace ABC Powder ILP Unit to 195 psig at 70 °F [13.4 bar at 21.1 °C].
6. Shake the system thoroughly to ensure the nitrogen is absorbed by the ABC Powder.
7. Close the ball valve and leak test the Firetrace ABC Powder ILP Unit. If a leak detector is unavailable, a 48-hour holding period should be used to evaluate whether there is a leak.
8. The Firetrace ABC Powder ILP Unit is now ready to be transported to the installation site.

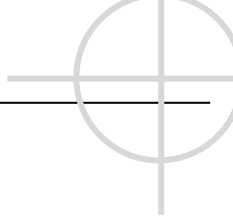
**NOTE:** Any maintenance requiring depressurization, filling, or pressurization shall only be performed at an authorized Firetrace service location. Service at any other location will void any warranty. Please contact Firetrace directly for a list of authorized Firetrace service locations.

#### **WARNING**

Only depressurize tubing **AFTER** the ball valve has been closed. Depressurizing the tubing without closing the ball valve may cause actuation of the unit, resulting in system discharge.

#### **WARNING**

Ball valve must **SLOWLY** be opened. Opening the ball valve abruptly, may cause actuation of the unit, resulting in system discharge.



---

## Section 8: Post Discharge

### 8.1 Ventilation

Before inspecting the enclosure after a Firetrace ABC Powder ILP Unit discharge, ventilate the enclosure thoroughly. ABC Powder will require clean-up operations after unit discharge.

### 8.2 Remove from Service

An authorized Firetrace distributor must be consulted after a system has discharged. The Firetrace ABC Powder ILP Unit must be removed and recharged. The Firetrace ABC Powder ILP unit should be removed using the following steps:

1. Remove the Firetrace detection tubing from the tube fitting attached to the top of the cylinder valve.
2. Remove the discharge piping from the discharge outlet ports.
3. Install the discharge outlet port plugs into both discharge outlet ports.
4. Remove the cylinder from the cylinder mounting bracket.
5. Have Firetrace ABC Powder ILP Unit recharged by a qualified Firetrace service location.

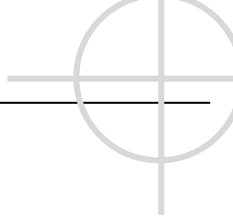
**NOTE:** Any maintenance requiring depressurization, filling, or pressurization shall only be performed at an authorized Firetrace service location. Service at any other location will void any warranty. Please contact Firetrace directly for a list of authorized Firetrace service locations.

### 8.3 Recharge

For Firetrace Pre-Engineered ABC Powder ILP Automatic Suppression Unit recharge instructions, refer to Section 7.

### 8.4 Return to Service

Please follow guidelines provided in Section 4 and Section 5 for returning a system to service.



## Appendix A – Parts List

### Firetrace ABC Powder ILP Automatic Suppression Unit Assemblies

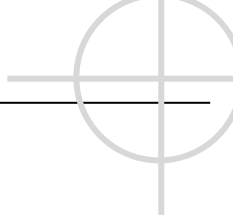
Table 37 – Firetrace ABC Powder ILP Units

Part Number	Description
940202	Small ABC Powder ILP Suppression Unit (2.5 lb)
940502	Medium ABC Powder ILP Suppression Unit (5 lb)
941002	Large ABC Powder ILP Suppression Unit (10 lb)
942002	Extra Large ABC Powder ILP Suppression Unit (20 lb)

### Heavy Duty Brackets

Table 38 – Heavy Duty Bracket Assembly

Part Number	Description
111404	Small Heavy Duty Bracket w/ Clamps
111403	Medium Heavy Duty Bracket w/ Clamps
111402	Large Heavy Duty Bracket w/ Clamps
111400	Extra Large Heavy Duty Bracket w/ Clamps



## Discharge Network

**Table 39 – Small ILP Discharge Network Copper Fittings**

Part Number	Description
200143	Copper Compression Fitting, Valve/Nozzle to 5/16 in Pipe
200101	Copper Compression Fitting, 5/16 in Pipe Bulkhead
200111	Copper Compression Fitting, 5/16 in Pipe Elbow
200121	Copper Compression Fitting, 5/16 in Pipe Tee

**Table 40 – Medium/Large ILP Discharge Network Copper Fittings**

Part Number	Description
200144	Copper Compression Fitting, Valve/Nozzle to 1/2 in Pipe
200145	Copper Compression Fitting, 1/2 in Pipe Bulkhead
200112	Copper Compression Fitting, 1/2 in Pipe Elbow
200122	Copper Compression Fitting, 1/2 in Pipe Tee

**Table 41 – Small ILP Discharge Network Flexible Hoses**

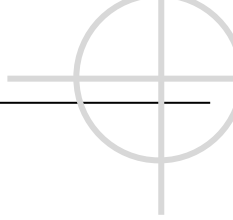
Part Number	Description
202816 <sup>**</sup>	3/8 in Flexible Hose, 1 ft
201816 <sup>**</sup>	3/8 in Flexible Hose, 2 ft
201817 <sup>**</sup>	3/8 in Flexible Hose, 3 ft
201818 <sup>**</sup>	3/8 in Flexible Hose, 4 ft
201819 <sup>**</sup>	3/8 in Flexible Hose, 7 ft

**Table 42 – Medium/Large ILP Discharge Network Flexible Hoses**

Part Number	Description
202820 <sup>**</sup>	1/2 in Flexible Hose, 1 ft
201820 <sup>**</sup>	1/2 in Flexible Hose, 2 ft
201821 <sup>**</sup>	1/2 in Flexible Hose, 4 ft
201822 <sup>**</sup>	1/2 in Flexible Hose, 6 ft
201823 <sup>**</sup>	1/2 in Flexible Hose, 8 ft
201824 <sup>**</sup>	1/2 in Flexible Hose, 10 ft

<sup>\*\*</sup> Not part of an FM Approved System





**Table 43 – Small ILP Discharge Network Flexible Hose Fittings**

<b>Part Number</b>	<b>Description</b>
850016 <sup>§§</sup>	Fitting, 3/8 in Hose to Valve Union
850017 <sup>§§</sup>	Fitting, 3/8 in Hose Union
850018 <sup>§§</sup>	Fitting, 3/8 in Hose Elbow
850019 <sup>§§</sup>	Fitting, 3/8 in Hose Tee
850020 <sup>§§</sup>	Fitting, 3/8 in Hose to Nozzle Union Bulkhead
850021 <sup>§§</sup>	Fitting, 3/8 in Hose to Nozzle Elbow Bulkhead

**Table 44 – Medium/Large ILP Discharge Network Flexible Hose Fittings**

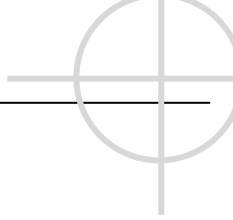
<b>Part Number</b>	<b>Description</b>
850022 <sup>§§</sup>	Fitting, 1/2 in Hose to Valve Union
850023 <sup>§§</sup>	Fitting, 1/2 in Hose Union
850024 <sup>§§</sup>	Fitting, 1/2 in Hose Elbow
850025 <sup>§§</sup>	Fitting, 1/2 in Hose Tee
850026 <sup>§§</sup>	Fitting, 1/2 in Hose to Nozzle Union Bulkhead
850027 <sup>§§</sup>	Fitting, 1/2 in Hose to Nozzle Elbow Bulkhead

**Table 45 – Nozzles**

<b>Part Number</b>	<b>Description</b>
500001	Small Dry Chemical Nozzle, 1/4 NPT
500002	Medium Dry Chemical Nozzle, 1/2 NPT
510017 <sup>§§</sup>	Small Nozzle Cap
510018 <sup>§§</sup>	Medium Nozzle Cap
510019 <sup>§§</sup>	Medium Blow-Off Cap

---

<sup>§§</sup> Not part of an FM Approved System



## Detection Network

**Table 46 – Firetrace Detection Tubing**

Part Number	Description
200005	Firetrace Detection Tubing, 4/6 mm, 1 ft
204025	Firetrace Detection Tubing, 4/6 mm, 25 ft
204050	Firetrace Detection Tubing, 4/6 mm, 50 ft
204100	Firetrace Detection Tubing, 4/6 mm, 100 ft
204328	Firetrace Detection Tubing, 4/6 mm, 328 ft

**Table 47 – Tube Fittings**

Part Number	Description
200157	Fitting, Tube Tee, 4/6 mm
200158	Fitting, Tube Union, 4/6 mm
200159	Fitting, Tube to Threads Elbow, 4/6 mm
200177	Fitting, Tube Tee to Threads, 4/6 mm
200178	Fitting, Tube Elbow, 4/6 mm
200179	Fitting, Tube to Threads Union, 4/6 mm
200203***	Fitting, Tube Plug, 4/6 mm
200169	In Line Adapter w/ Tube Tee, 4/6 mm

**Table 48 – End of Line Accessories**

Part Number	Description
200168	End of Line Adapter w/ Tube Union, 4/6 mm
400028	Pressure Gauge w/ O-Ring, 195 psig
310303	End of Line Adapter Plug
400004	End of Line Pressure Switch
600063***	Manual Release w/ 195 psig Gauge and Tube Union, 4/6 mm
601012	2 <sup>nd</sup> Gen Manual Release w/ 195 psig Gauge and Tube Union, 4/6 mm

\*\*\* Not part of an FM Approved System

## Miscellaneous

**Table 49 – Installation Accessories**

Part Number	Description
200150	Rubber Grommets for Detection Tubing (Qty. 2)
200151	Plastic Grommets for Detection Tubing (Qty. 2)
200171	Mounting tabs for Detection Tubing, 4/6 mm (Qty. 12)
201006 <sup>+++</sup>	Magnetic Mounting Clips for Detection Tubing, 4/6 mm (Qty. 6)
201133 <sup>+++</sup>	Heavy Duty Mounting Clips for Detection Tubing (Qty. 6)
600213 <sup>+++</sup>	Detection Tubing Charge Kit
600210 <sup>+++</sup>	Tube Cutter
201132 <sup>+++</sup>	Tamperproof Device, "ON" position
201137 <sup>+++</sup>	Tamperproof Device, "OFF" position
120305 <sup>+++</sup>	Accessory Mounting Brackets

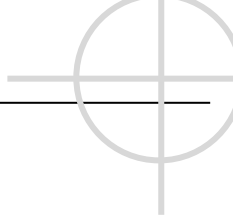
**Table 50 – Auxiliary Accessories**

Part Number	Description
400001	Valve Mounted Pressure Switch
400441 <sup>+++</sup>	Pressure Switch Assembly Box
400312 <sup>+++</sup>	12 VDC Electric Solenoid Assembly
400324 <sup>+++</sup>	24 VDC Electric Solenoid Assembly
400316 <sup>+++</sup>	120 VAC Electric Solenoid Assembly
400327 <sup>+++</sup>	240 VAC Electric Solenoid Assembly
600096 <sup>+++</sup>	Black Audible Alarm, Battery Operated (requires pressure switch)


**Table 51 – Indication and Activation Kits**

Part Number	Description
600410-12 <sup>+++</sup>	12 VDC Indication Kit, 195 psig, Bottom Cable
600420-12 <sup>+++</sup>	12 VDC Indication and Activation Kit, 195 psig, Bottom Cable
600408-12 <sup>+++</sup>	12 VDC Indication Kit, 195 psig, Rear Cable
600409-12 <sup>+++</sup>	12 VDC Indication and Activation Kit, 195 psig, Rear Cable
600410-24 <sup>+++</sup>	24 VDC Indication Kit, 195 psig, Bottom Cable
600420-24 <sup>+++</sup>	24 VDC Indication and Activation Kit, 195 psig, Bottom Cable
600408-24 <sup>+++</sup>	24 VDC Indication Kit, 195 psig, Rear Cable

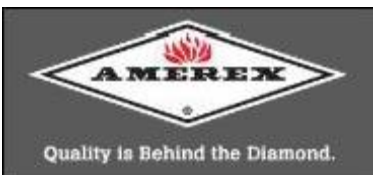
<sup>+++</sup> Not part of an FM Approved System



## Appendix B – System Commissioning Form

			
<p>POWER TO INNOVATE. FLEXIBILITY TO ADAPT.          8435 N. 90<sup>th</sup> Street, Suite 2, Scottsdale, AZ 85258 USA · +1.480.607.1218 · +1.480.315.1316 · www.firetrace.com</p>			
<b>Firetrace Pre-Engineered ABC Powder ILP Automatic Suppression Unit</b>			
<b>System Commissioning Form</b>			
<b>System Serial Number:</b>		<b>Installation Date:</b>	
<b>Installed by:</b>		<b>Company:</b>	
<b>Description</b>	<b>Performed by</b>	<b>Date</b>	
Mounting Bracket installed using two or more mounting holes.			
ABC Powder agitated.			
Cylinder positioned in mounting bracket with the pressure gauge facing out.			
Cylinder secured in place using bracket straps or band clamps.			
Nozzle(s) secured in optimal location.			
Nozzle(s) within limitations outlined in Section 3 of DIOM manual.			
Necessary Discharge port plug(s) removed and adapters installed.			
Discharge piping installed between discharge port(s) and nozzle(s).			
Discharge piping secured in place.			
Discharge piping is within limitations outlined in Section 3 of DIOM manual.			
Tubing and fittings installed and secured throughout the protected enclosure.			
Tube fitting threaded into ball valve attached to the top of the cylinder valve.			
Detection tubing inserted into tube fitting.			
Detection network is within limitations outlined in section 3 of DIOM manual.			
Detection network pressurized to 195 psig.			
Pressure gauge or equivalent installed into end of line adapter.			
Leak check conducted on detection network.			
Ball valve on top of cylinder valve rotated to "ON" position.			
Tamperproof device installed on ball valve lever.			
Electrical connections properly made in accordance with NFPA 70 and NFPA 72.			

# Appendix C – SDS



## SAFETY DATA SHEET

### Section 1. PRODUCT AND COMPANY IDENTIFICATION

Product Name: ABC Dry Chemical Fire Extinguishant  
 Other Identifiers: Multi-purpose Dry Chemical  
 Product Code(s): CH555, F13, F11  
 Model Code(s) of Extinguishers: 402, IS 18ABC, IS35ABC, IS 45ABC, 13ABC, V25ABC, VH25ABC, V30ABC, VH30ABC, V50ABC, VS50ABC, VS75ABC, V250ABC  
 Recommended Use: Fire suppression, not for human or animal drug use.  
 Manufacturer: AMEREX CORPORATION  
 Internet Address: [www.amerex-fire.com](http://www.amerex-fire.com)  
 Address: 7595 Gadsden Highway, P.O. Box 81 Trussville, AL 35173-0081  
 Company Telephone: (205) 655-3271  
 E-mail Address: [info@amerex-fire.com](mailto:info@amerex-fire.com)  
 Emergency Contacts: Chemtrec 1(800) 424-9300 or (703) 527-3887  
 Revised: May, 2016

### Section 2. HAZARDS IDENTIFICATION

#### GHS – Classification

Health	Environmental	Physical
Acute Toxicity: Category 5	None	None
Skin Corrosion/Irritation: Category 3	None	None
Skin Sensitization: NO	None	None
Eye: Category 2B	None	Warning
STOT – Category 3	None	Warning
Carcinogen: Category None	None	None

GHS – Label Symbol(s):

Exclamation Mark

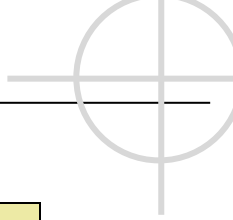


GHS – Word(s):

Warning

Other Hazards Not Resulting in Classification:

None



**GHS – Hazard Phrases**

GHS Hazard	GHS Code(s)	Code Phrase(s)
Physical	None	
Health	H303 316 320 335	May be harmful if swallowed Causes mild skin irritation Causes eye irritation May cause respiratory irritation
Environmental	None	
Precautionary:		
General	P101	If medical advice is needed, have product container or label at hand
Prevention	261 264	Avoid breathing dust Wash hands and face thoroughly after handling
Response	P304+340 305+351+313  337+338  312	If inhaled, remove person to fresh air and keep comfortable for breathing. If in eyes, rinse cautiously with water for several minutes. Get immediate medical advice/attention (as appropriate). If eye irritation persists: remove contact lenses, if present and easy to do. Continue rinsing. Call a POISON CENTER/doctor if you feel unwell (as appropriate).
Storage	None	

**Section 3. COMPOSITION/INFORMATION ON INGREDIENTS**

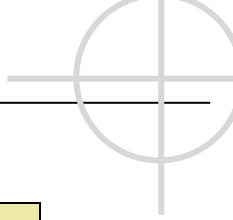
Chemical Name	EC No.	REACH Reg. No.	CAS-No.	Weight%	Classification
Mono-ammonium phosphate	NA	NA	7722-76-1	90-97	NA
Fullers earth magnesium aluminum silicate	NA	Not Available	8031-18-3	>3	NA
Mica- potassium aluminum silicate	NA	Not Available	12001-26-2	1-2	NA
Silicone oil methyl hydrogen polysiloxane	NA	Not Available	63148-57-2	<1	NA
Calcium carbonate	215-279-6	Not Available	1317-65-3	<1	NA
Amorphous silica precipitated synthetic zeolite	262-373-8	Not Available	112926-00-8	<1	NA
Yellow 14 pigment – di-azo dye	228-767-9	Not Available	5468-75-7	<1	NA

Emergency overview:

Light yellow, fine solid powder, odorless.

Adverse health effects and symptoms:

Mild irritant to the respiratory system, eyes, and skin. Symptoms may include coughing, shortness of breath, and irritation of the lungs, eyes, and skin. Ingestion, although unlikely, may cause cramps, nausea and diarrhea.



**Cut-off Levels**

<b>Chemical Name</b>	<b>Reproductive Toxicity</b>	<b>Carcinogenicity</b>	<b>Mutagenicity</b>	<b>Other Hazard Classes</b>
Mono-ammonium phosphate	NA	NA	NA	NA
Fullers earth magnesium aluminum silicate	NA	NA	NA	NA
Mica- potassium aluminum silicate	NA	NA	NA	NA
Silicone oil methyl hydrogen polysiloxane	NA	NA	NA	NA
Calcium carbonate	NA	NA	NA	NA
Amorphous silica precipitated synthetic zeolite	NA	NA	NA	NA
Yellow 14 pigment – di-azo dye	NA	NA	NA	NA

**Section 4. FIRST AID MEASURES**

Eye Exposure:

May cause irritation. Irrigate eyes with water and repeat until pain free. Seek medical attention if irritation develops, or if vision changes occur.

Skin Exposure:

May cause skin irritation. In case of contact, wash with plenty of soap and water. Seek medical attention if irritation persists.

Inhalation:

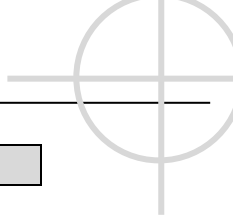
May cause irritation, along with coughing. If respiratory irritation or distress occurs, remove victim to fresh air. Seek medical attention if irritation persists.

Ingestion:

Overdose symptoms may include numbness or tingling in hands or feet, uneven heart rate, paralysis, feeling faint, chest pain or heavy feeling, pain spreading to the arm or shoulder, nausea, diarrhea, sweating, general ill feeling, or seizure (convulsions). If victim is conscious and alert, give 2-3 glasses of water to drink. If conscious, do not induce vomiting. Seek immediate medical attention. Do not leave victim unattended. To prevent aspiration of swallowed product, lay victim on side with head lower than waist.

Medical conditions possibly aggravated by exposure:

Inhalation of product may aggravate existing chronic respiratory problems such as asthma, emphysema, or bronchitis. Skin contact may aggravate existing skin disease. Chronic overexposure may cause pneumoconiosis (“dusty lung” disease).



## Section 5. FIRE-FIGHTING MEASURES

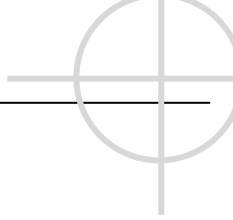
Flammable Properties:	Not flammable
Flash Point:	Not determined
Suitable Extinguishing Media:	Non-combustible. Use extinguishing media suitable for surrounding conditions.
Hazardous Combustion Products:	Carbon oxides
<u>Explosion Data:</u>	
Sensitivity to Mechanical Impact:	Not sensitive
Sensitivity to Static Discharge:	Not sensitive
Unusual fire/explosion hazards:	In a fire, this material may decompose, releasing oxides of carbon, potassium and nitrogen (see Section 10).
Protective Equipment and Precautions for Firefighters:	As in any fire, wear self-contained breathing apparatus pressure-demand. NIOSH (approved or equivalent), and full protective gear.

## Section 6. ACCIDENTAL RELEASE MEASURES

Personal Precautions:	Avoid contact with skin, eyes, and clothing.
Personal Protective Equipment:	Minimum - safety glasses, gloves, and a dust respirator.
Emergency Procedure:	NA
Methods for Containment:	Prevent further leakage or spillage if safe to do so.
Methods for Clean Up:	Avoid dust formation. Clean up released material using vacuum or wet sweep and shovel to minimize generation of dust. Bag and transfer to properly labeled containers. Ventilate area and wash spill site after material pickup is complete.
Other:	If product is contaminated, use PPE and containment appropriate to the nature of the most toxic chemical/material in the mixture.







Personal Protective Equipment – PPE Code E:

The need for respiratory protection is not probable during short-term exposure. PPE use during production process must be independently evaluated.



Eye/Face Protection:  
Skin and Body Protection:  
Respiratory Protection:

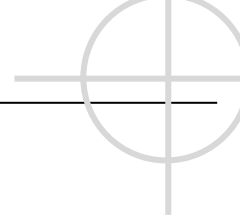
Tightly fitting safety goggles  
Wear protective gloves/coveralls  
If exposure limits are exceeded or irritation is experienced, NIOSH approved respiratory protection should be worn. Use P100 respirators for limited exposure, use air-purifying respirator (APR) with high efficiency particulate air (HEPA) filters for prolonged exposure. Positive-pressure supplied air respirators may be required for high airborne contaminant concentrations. Respiratory protection must be provided in accordance with current safety and health requirements. The need for respiratory protection is not likely for short-term use in well ventilated areas.

Hygiene Measures:

Good personal hygiene practice is essential, such as avoiding food, tobacco products, or other hand-to-mouth contact when handling. Wash thoroughly after handling.

**Section 9. PHYSICAL AND CHEMICAL PROPERTIES**

Appearance:	Light yellow powder, finely divided odorless solid
Molecular Weight:	115.03
Odor:	Odorless
Odor Threshold:	No information available
Decomposition Temperature °C:	100 – 120
Freezing Point °C:	No information available
Initial Boiling Point °C:	No information available
Physical State:	Crystalline Powder
pH:	Approximately 4.4 to 4.9
Flash Point °C:	None



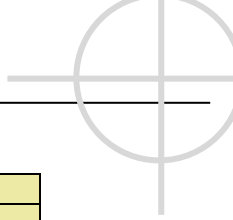
Autoignition Temperature °C:	None
Boiling Point/Range °C:	Not Applicable
Melting Point/Range °C:	190 C
Flammability Limits in Air °C:	Upper – Not Flammable; Lower-Not Flammable
Explosive Properties:	None
Oxidizing Properties:	None
Volatile Component (%vol)	Not Applicable
Evaporation Rate:	Not Applicable
MMHG @ 37.8 C :	Not Applicable
Vapor Density:	Not Applicable
Vapor Pressure:	Not Applicable
Specific gravity:	Approximately 1.8 at 25 C
Solubility:	40.4 g/100 ml
Partition Coefficient:	No Information Available
Viscosity:	Not Applicable

## Section 9. STABILITY AND REACTIVITY

Stability:	Stable under recommended storage and handling conditions.
Incompatibles:	Strong oxidizing agents; Strong acids; sodium hypochlorite and chlorine compounds. Protect from moisture
Conditions to Avoid:	Storage or handling near incompatibles.
Hazardous Decomposition Products:	Carbon, nitrogen, and potassium oxides. Heat of fire may release carbon monoxide.
Possibility of Hazardous Reactions:	None
Hazardous Polymerization	Does not occur

## Section 11. TOXICOLOGICAL INFORMATION

Likely Routes of Exposure:	Inhalation, skin and eye contact.
Symptoms:	
Inhalation:	Irritation, coughing.
Eyes:	Irritation.
Skin:	Irritation.
Acute Toxicity:	Relatively non-toxic.
Chronic Toxicity:	
Short-term Exposure:	None known.
Long-term Exposure:	As with all dusts, pneumoconiosis, or “dusty lung” disease, may result from chronic exposure.



**Acute Toxicity Values - Health**

Chemical Name	LD50		LC50 (Inhalation)
	Oral	Dermal	
Mono-ammonium phosphate	5750 mg/kg (rat)	>7940 mg/kg (rabbit)	Not available
Mica	None	None	None
Fullers Earth	None	None	None
Silicone oil	None	None	None
Calcium carbonate	6450 mg/kg (rat)	500 mg/24 hr (rabbit)	Not available
Amorphous silica	>5000 mg/kg (rat)	>2000 mg/kg (rabbit)	>2.2 mg/L (rat)
Yellow 14 pigment	>17000 mg/kg (rat)	>3000 mg/kg (rat)	>4448 mg/m <sup>3</sup> (rat)

Reproductive Toxicity:

This product's ingredients are not known to have reproductive or teratogenic effects.

Target Organs and Effects (TOST):

Respiratory system (mild irritant).  
This product is a mild irritant to epithelial tissue, (eyes, mucous membranes, skin) and may aggravate dermatitis. No information was found indicating the product causes sensitization.

**Other Toxicity Categories**

Chemical Name	Germ Cell Mutagenicity	Carcinogenicity	Reproductive	TOST Single Exp	TOST Repeated Exp	Aspiration
Potassium Bicarbonate	None	None	None	Cat 3	None	None
Fullers Earth	None	None	None	None	None	None
Mica	None	None	None	None	None	None
Silicone oil	None	None	None	None	None	None
Calcium carbonate	None	None	None	None	None	None
Amorphous silica	None	None	None	None	None	None
Yellow 14 pigment	None	None	None	None	None	None

**Section 12. ECOLOGICAL INFORMATION**

Ecotoxicity:

Negative effects unknown. Provides nutrient nitrogen and phosphorus to plant life.

Persistence/Degradability:

Degrades rapidly in humid/wet environment.

Bioaccumulation:

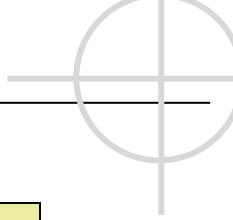
Extent unknown.

Mobility in soil:

Slow evaporation rate; water soluble, may leach to groundwater.

Other Adverse Ecological Effects:

No other known effects at this time.



**Aquatic Toxicity Values – Environment – None Known**

<b>Chemical Name</b>	<b>Acute (LC50)</b>	<b>Chronic (LC50)</b>
Mono-ammonium phosphate	N/A	N/A
Mica	N/A	N/A
Fullers Earth	N/A	N/A
Silicone oil	N/A	N/A
Calcium carbonate	N/A	N/A
Amorphous silica	N/A	N/A
Yellow 14 pigment	N/A	N/A

**Section 13. DISPOSAL CONSIDERATIONS**

Safe Handling Use appropriate PPE when handling, and wash thoroughly after handling (see Section 8).

Waste Disposal Considerations Dispose in accordance with federal, state, and local regulations.

Contaminated Packaging Dispose in accordance with federal, state, and local regulations.

**NOTES:**

This product is not a RCRA characteristically hazardous or listed hazardous waste. Dispose of according to state or local laws, which may be more restrictive than federal laws or regulations. Used product may be altered or contaminated, creating different disposal considerations.

**Section 14. TRANSPORT INFORMATION**

UN Number: NA

UN Proper Shipping Name: NA

Transport Hazard Class: NA

Packing Group: NA

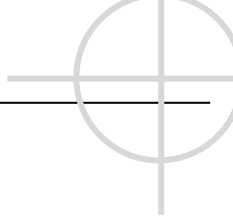
Marine Pollutant?: NO

IATA Not regulated

DOT Not regulated

**NOTES:**

This product is not defined as a hazardous material under U.S. Department of Transportation (DOT) 49 CFR 172, or by Transport Canada "Transportation of Dangerous Goods" regulations. Special Precautions for Shipping:



If shipped in a stored pressure-type fire extinguisher, and pressurized with a non-flammable, non-toxic inert expellant gas, the fire extinguisher is considered a hazardous material by the US Department of Transportation and Transport Canada. The proper shipping name shall be FIRE EXTINGUISHER and the UN designation is UN 1044. The DOT hazard class is Limited Quantity when shipped via highway or rail. Use a Non-Flammable Gas label (class 2.2) when shipping via air.

**Section 15. REGULATORY INFORMATION**

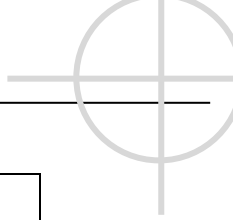
**International Inventory Status:** All ingredients are on the following inventories

Country(ies)	Agency	Status
United States of America	TSCA	Yes
Canada	DSL	Yes
Europe	EINECS/ELINCS	Yes
Australia	AICS	Yes
Japan	MITI	Yes
South Korea	KECL	Yes

**REACH Title VII Restrictions:** No information available

Chemical Name	Dangerous Substances	Organic Solvents	Harmful Substances Whose Names Are to be Indicated on Label	Pollution Release and Transfer Registry (Class II)	Pollution Release and Transfer Registry (Class I)	Poison and Deleterious Substances Control Law
Mono-ammonium Phosphate	Not Applicable	Not Applicable	Not Applicable	Not Applicable	Not Applicable	Not Applicable

Component	ISHA – Harmful Substances Prohibited for Manufacturing, Importing, Transferring, or Supplying	ISHA – Harmful Substances Requiring Permission	Toxic Chemical Classification Listing (TCCL) – Toxic Chemicals	Toxic Release Inventory (TRI) – Group I	Toxic Release Inventory (TRI) – Group II
Mono-ammonium Phosphate 7722-76-1	Not Applicable	Not Applicable	Not Applicable	Not Applicable	Not Applicable
Fullers earth magnesium aluminum silicate 8031-18-3 (>4)	Not Applicable	Not Applicable	Not Applicable	Not Applicable	Not Applicable
Mica-potassium aluminum silicate 120001-26-2 (>2)	Not Applicable	Not Applicable	Not Applicable	Not Applicable	Not Applicable



Calcium carbonate 471-34-1	Not Applicable	Not Applicable	Not Applicable	Not Applicable	Not Applicable
Amorphous silica 69012-64-2	Not Applicable	Not Applicable	Not Applicable	Not Applicable	Not Applicable
Yellow 14 pigment 5468-75-7	Not Applicable	Not Applicable	Not Applicable	Not Applicable	Not Applicable

**European Risk and Safety phrases:**

EU Classification:	XN	Irritant
R Phrases:	20	Harmful by inhalation.
	36/37	Irritating to eyes, respiratory system.
S Phrases:	22	Do not breath dust.
	24/25	Avoid contact with skin and eyes.
	26	In case of contact with eyes, rinse immediately with plenty of water and seek medical advice.
	36	Wear suitable protective clothing.

**U.S. Federal Regulatory Information:**

SARA 313:  
Section 313 of Title III of the Superfund Amendments and Reauthorization Act of 1986 (SARA) - This product does not contain and chemicals which are subject to the reporting requirements of the Act and Title 40 of the Code of Federal Regulations, Part 372.  
None of the chemicals in this product are under SARA reporting requirements or have SARA threshold planning quantities (TPQs) or CERCLA reportable quantities (RQs), or are regulated under TSCA 8(d).

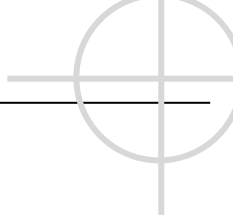
**SARA 311/312 Hazard Categories:**

Acute Health Hazard	Yes
Chronic Health Hazard	No
Fire Hazard	No
Sudden Release of Pressure Hazard-*	Yes
Reactive Hazard	No

\* - Only applicable if material is in a pressurized extinguisher.

**Clean Water/Clean Air Acts:**

This product does not contain any substances regulated as pollutants pursuant to the Clean Water Act (40 CFR 122.21 and 40 CFR 122.42) or Clean Air Act, Section 112, Hazardous Air Pollutants (HAPs) (see 40 CFR 61) and Section 112 of the Clean Air Act Amendments of 1990.



**U.S. State Regulatory Information:**

Chemicals in this product are covered under specific State regulations, as denoted below:

- Alaska** - Designated Toxic and Hazardous Substances: None
- California** – Permissible Exposure Limits for Chemical Contaminants: None
- Florida** – Substance List: Mica Dust
- Illinois** – Toxic Substance List: None
- Kansas** – Section 302/303 List: None
- Massachusetts** – Substance List: Mica Dust
- Minnesota** – List of Hazardous Substances: None
- Missouri** – Employer Information/Toxic Substance List: None
- New Jersey** – Right to Know Hazardous Substance List: None
- North Dakota** – List of Hazardous Chemicals, Reportable Quantities: None
- Pennsylvania** – Hazardous Substance List: None
- Rhode Island** – Hazardous Substance List: Mica Dust
- Texas** – Hazardous Substance List: No
- West Virginia** – Hazardous Substance List: None
- Wisconsin** – Toxic and Hazardous Substances: None

California Proposition 65: No component is listed on the California Proposition 65 list.

**Other:**

- |                             |                     |
|-----------------------------|---------------------|
| Mexico – Grade              | No component listed |
| Canada – WHMIS Hazard Class | No component listed |

**Section 16. OTHER INFORMATION**

This SDS conforms to requirements under U.S., U.K., Canadian, Australian, and EU regulations or standards, and conforms to the proposed 2003 ANSI Z400.1 format.

Issuing Date	17-June-2012
Revision Date	4-May-2016
Revision Notes	None

The information herein is given in good faith but no warranty, expressed or implied, is made.  
Updated by William F. Garvin, CIH.